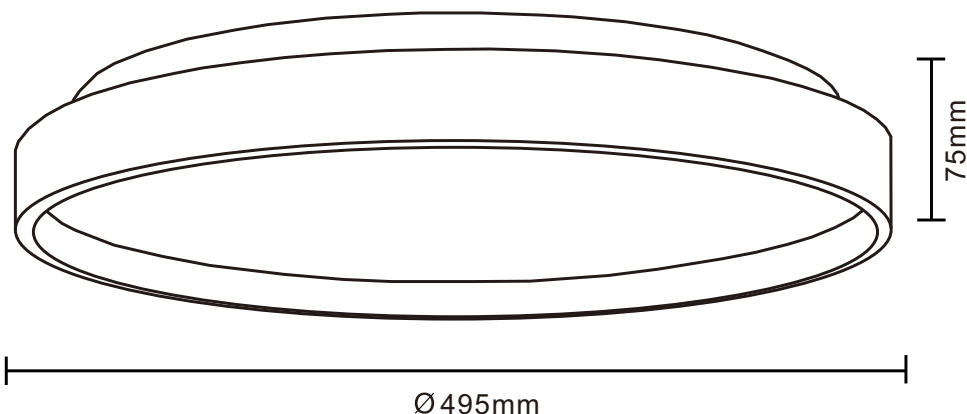

10013322

29W LED / 30W Total
incl. LED Board: L9002749
220-240V ~ 50/60Hz

(DE) Bestimmungsgemäße Verwendung

(GB) Intended use / (FR) Utilisation conforme / (NL) Beoogd gebruik / (PL) Stosowanie zgodnie z przeznaczeniem /
(NO) Riktig bruk / (DK) Korrekt brug / (SE) Avsedd användning / (FI) Määräystenmukainen käyttö

(IT) Impiego appropriato / (ES) Uso prescrito / (CZ) Použití v souladu s určením / (PT) Utilização correta / (GR) Ενδεδειγμένη χρήση

(DE)	Ortsfeste Verwendung als Deckenleuchte im Innenbereich	(GB)	Provided for stationary indoor use on ceilings
(FR)	Installation fixe en tant que plafonnier à l'intérieur	(NL)	Vast gebruik als plafondlamp binnenshuis
(PL)	Do montażu stacjonarnego jako lampa sufitowa do wnętrz	(NO)	Til stasjonært bruk som taklampe innendørs
(DK)	Til stationær brug som loftlampe indendørs	(SE)	Används som fast taklampe inomhus
(FI)	Kiinteä käyttö sisätilojen kattovalaisimena	(IT)	Impiego fisso come plafoniera in ambienti interni
(ES)	Empleo fijo como lámpara de techo en interiores	(CZ)	Stacionární použití jako stropní svítidlo v interiéru
(PT)	Aplicação fixa como luminária de teto em interiores	(GR)	Σταθερή χρήση ως φωτιστικό οροφής σε εσωτερικό χώρο

(DE) Verwendete Symbole

(GB) Safety Precautions / (FR) Symboles utilisés / (NL) Gebruikte symbolen / (PL) Stosowane symbole / (NO) Brukte symboler /
(DK) Brugte symboler / (SE) Använda symboler / (FI) Käytetyt symbolit / (IT) Simboli usati / (ES) Símbolos empleados /
(CZ) Použité symboly / (PT) Símbolos utilizados / (GR) Χρησιμοποιούμενα σύμβολα

IP 20

(DE) Lieferumfang

(GB) Package contents / (FR) Contenu de la livraison / (NL) Bij de levering inbegrepen / (PL) Zakres dostawy / (NO) Leveringsomfang / (DK) Leveringsomfang / (SE) Leveransomfattning / (FI) Toimitussisältö / (IT) Fornitura / (ES) Volumen de suministro / (CZ) Rozsah dodávky / (PT) Material fornecido / (GR) Παραδοτέος εξοπλισμός

(DE)	1 Deckenleuchte Montagematerial Montageanleitung	(GB)	1 Ceiling lamp Installation hardware Mounting instructions	(FR)	1 Plafonnier Matériel de montage Instructions de montage
(NL)	1 Plafondlamp Monteringsmateriale Montagehandleiding	(PL)	1 Lampa sufitowa Elementy montażowe Instrukcja montażu	(NO)	1 Taklampe Monteringsmateriale Brukerveiledning
(DK)	1 Loftlampe Monteringsmateriale Brugervejledning	(SE)	1 Taklampe Monteringsmaterial Monteringsanvisning	(FI)	1 Kattovalaisin Asennus materiaali Asennusohjeet
(IT)	1 Plafoniera Materiale di montaggio Istruzioni di montaggio	(ES)	1 Lámpara de techo Material de montaje Instrucciones de montaje	(CZ)	1 Stropní svítidlo Materiál pro montáž Návod k montáži
(PT)	1 Luminária de teto Material de montagem Instruções de montagem	(GR)	1 Φωτιστικό οροφής Υλικά συναρμολόγησης Οδηγίες συναρμολόγησης		



1

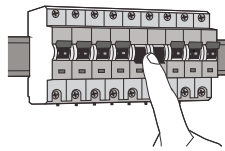

OFF

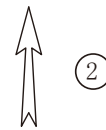
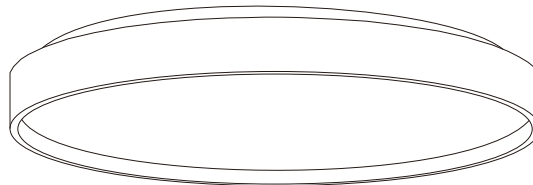
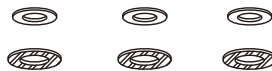
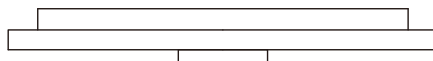
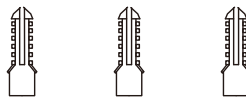
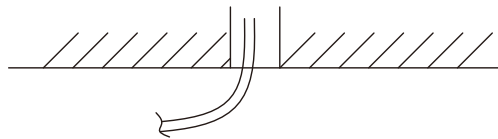
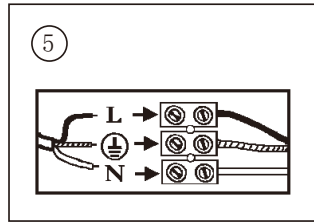

2



3

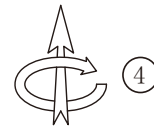

4

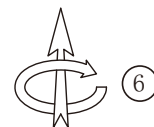

6

7

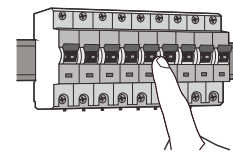

ON

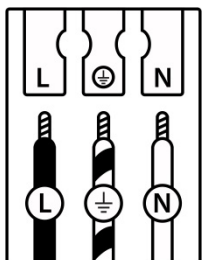

	(DE)	(GB)	(FR)	(NL)	(PL)	(NO)	(DK)
L	Stromführender Leiter	Live conductor	Conducteur	Spanningvoerende draad	Przewód prądowy	Strømførende leder	Strømførende leder
	Schutzleiter	Earth conductor	Conducteur de protection (terre)	Aardkabel	Przewód uziemiający	Jordledningen	Jordledningen
N	Neutralleiter	Neutral conductor	Conducteur neutre	Nulleider	Przewód zerowy	Nøytralleder	Neutralleider

	(SE)	(FI)	(IT)	(ES)	(CZ)	(PT)	(GR)
L	Strömförande ledare	Virtajohdin	Conduttore sotto tensione	Conductor de corriente	Vodič pod napětím	Condutor vivo	Ρευματοφόρος αγωγός
	Skyddsledare	Suojajohdin	Conduttore di terra	Conductor de protección	Ochranný vodič	Condutor de terra	Αγωγός γείωσης
N	Neutralledare	Nollajohdin	Conduttore neutro	Conductor neutro	Neutrální vodič	Condutor neutro	Ουδέτερος αγωγός

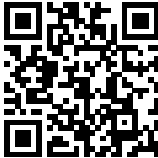
<p>(DE) Dieses Produkt enthält eine Lichtquelle der Energieeffizienzklasse E (EN) This product contains a light source of energy efficiency class E (FR) Ce produit comprend une source de lumière de classe d'efficience énergétique E (NL) Dit product bevat een lichtbron van energie-efficiëntieklasse E (PL) Produkt ten zawiera źródło światła o klasie efektywności energetycznej E (NO) Dette produktet inneholder en lyskilde i energieeffektivitetsklasse E (DK) Dette produkt indeholder en lyskilde af energieeffektklasse E (SE) Denna produkt innehåller en ljuskälla i energieffektivitetsklass E (FI) Tämä tuote sisältää energiatehokkuusluokan E valonlähteen (IT) Questo prodotto contiene una sorgente luminosa della classe di efficienza energetica E (ES) Este producto contiene una fuente de luz de la clase de eficiencia energética E (CZ) Tento výrobek obsahuje světelný zdroj třídy energetické účinnosti E (PT) Este produto contém uma fonte de luz da classe de eficiência energética E (GR) Αυτό το προϊόν περιέχει μια φωτεινή πηγή ενεργειακής απόδοσης κλάσης E (SK) Tento výrobok obsahuje zdroj svetla triedy energetickej efektivity E</p>	<p>QR</p> 	<p>EAN</p> <p>4251911773552</p>
--	---	---------------------------------

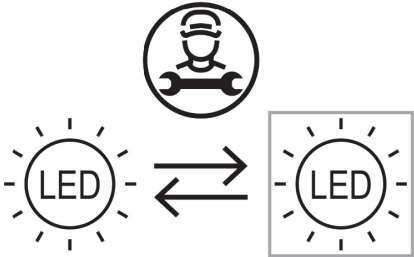
	<p>(DE) Durch einen Fachmann austauschbare Lichtquelle (nur LED). (EN) Replaceable (LED only) light source by a professional. (FR) Source de lumière remplaçable (LED uniquement) par un professionnel. (NL) Lichtbron (alleen led) te vervangen door een professional. (PL) Wymienne (tylko LED) źródło światła wykonane przez profesjonalistę. (NO) Utskiftbar (kun LED) lyskilde av en profesjonell. (DK) Udskiftelig lyskilde (kun LED), udskiftes af en elektriker. (SE) Ljuskälla (endast LED) utbytbar genom fackman. (FI) Ammattilainen voi vaihtaa vaihdettavan (vain LED) valonlähteen. (IT) Sorgente luminosa (solo LED) sostituibile da un professionista. (ES) Fuente de luz (solo LED) sustituible por un profesional. (CZ) Vyměnitelný (pouze LED) světelný zdroj odborníkem. (PT) Luz LED (apenas LED) substituível por um profissional. (GR) Η πηγή φωτός (μόνο LED) να αντικαθίσταται από επαγγελματία. (SK) Zdroj svetla (iba LED) vymeniteľný prostredníctvom odborníka.</p>
--	--

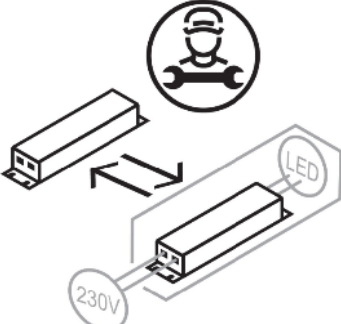
	<p>(DE) Durch einen Fachmann austauschbares Betriebsgerät. (EN) Replaceable control gear by a professional. (FR) Contrôleur remplaçable par un professionnel. (NL) Voorschakelapparatuur te vervangen door een professional. (PL) Wymienny układ sterujący przez profesjonalistę. (NO) Utskiftbar kontrollutstyr av en profesjonell. (DK) Udskiftelig igangsætter, udskiftes af en elektriker. (SE) Styrdon utbytbar genom fackman. (FI) Ammattilainen voi vaihtaa vaihdettavat ohjauslaitteet. (IT) Dispositivo di controllo sostituibile da un professionista. (ES) Dispositivo de control sustituible por un profesional. (CZ) Vyměnitelný předřadník odborníkem. (PT) Dispositivo de controlo substituível por um profissional. (GR) Ο εξοπλισμός ελέγχου να αντικαθίσταται από επαγγελματία. (SK) Predradník vymeniteľný prostredníctvom odborníka.</p>
---	--

GB

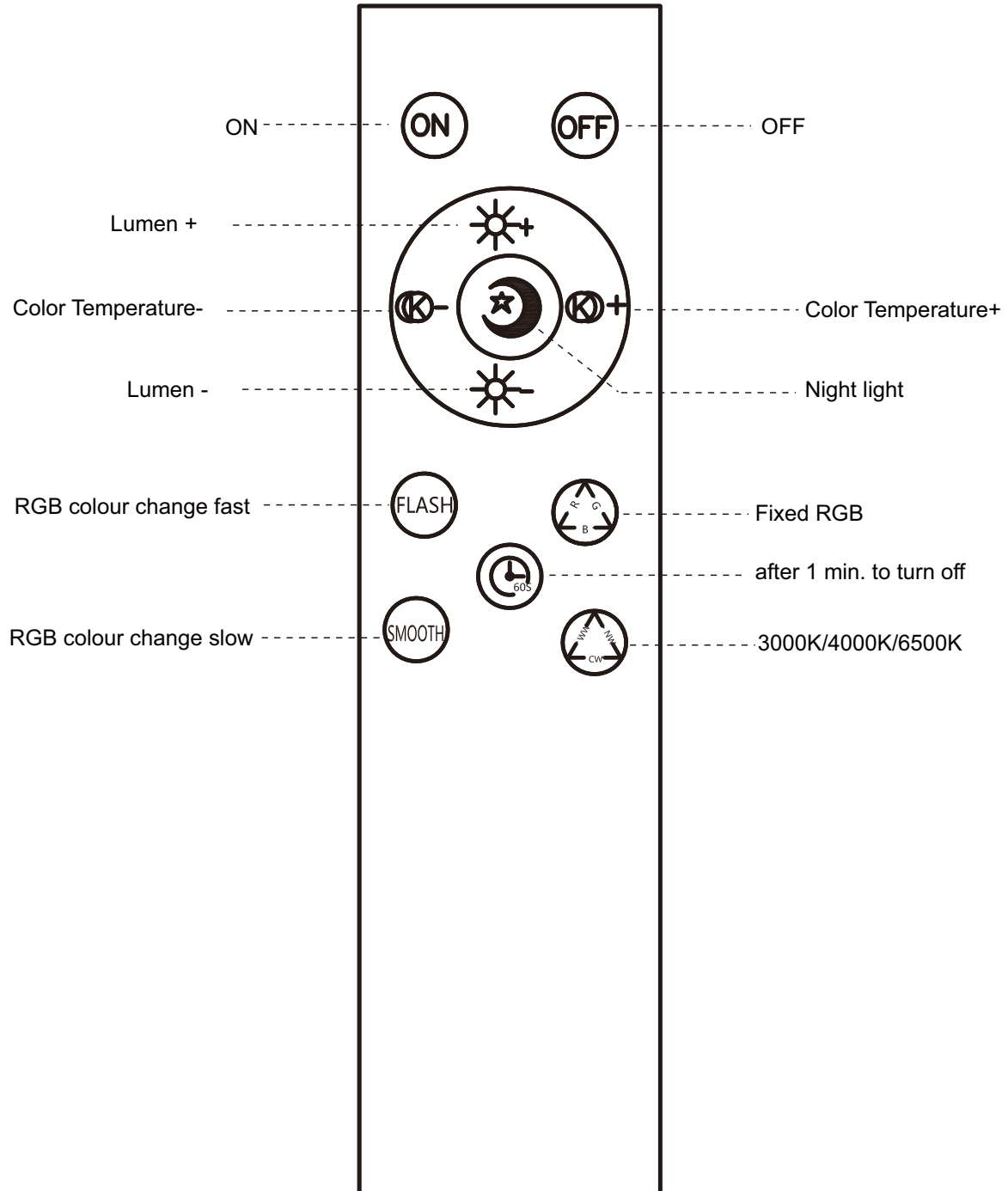

DE

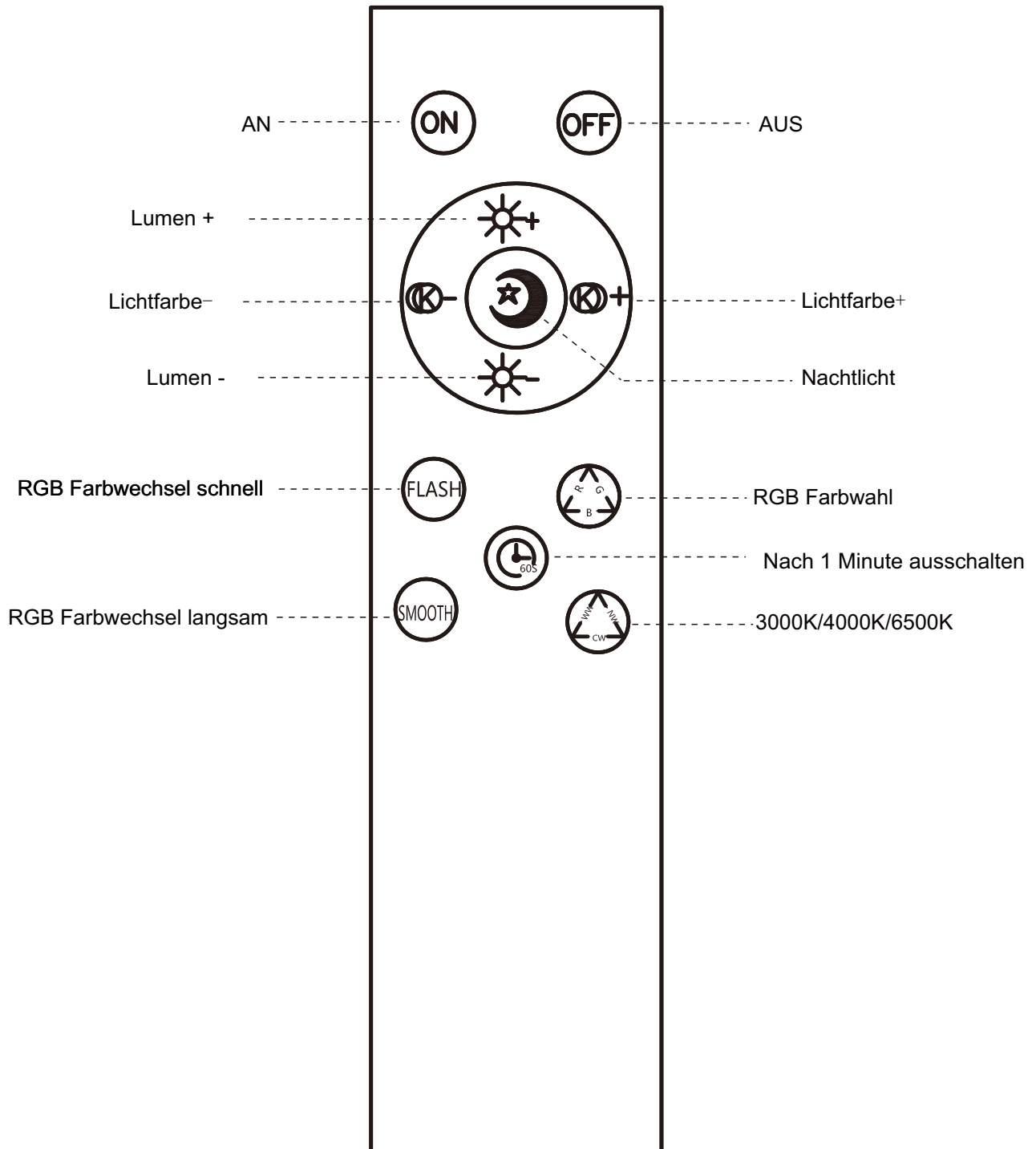

FR

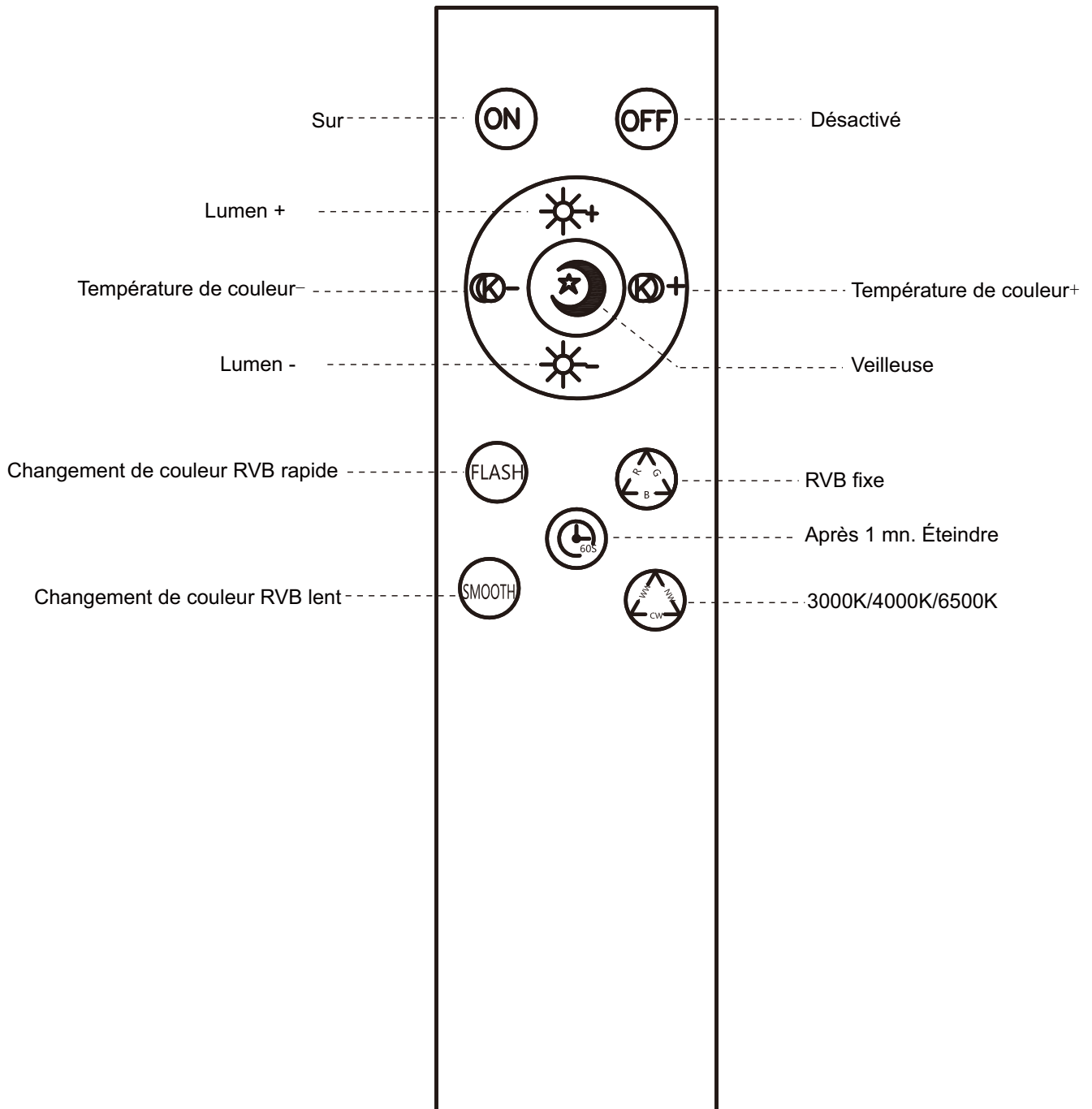

GB

1. APP installation

Search for the Tuya Smart App in the App Store or Google Play Store and install it on your device or scan the respective QR code here:

Play Store



App Store



2. Registration

Open the app and follow the instructions.

3. Connect with the app

3.1 Automatic connection

3.1.1 Make sure that there is sufficient WLAN coverage to connect the devices.
The closer the fixture is to the router, the faster and more secure the process will be.

3.1.2 Open the app and log in.

3.1.3 To add the luminaire in the app, it must be put into pairing mode. To do this, switch the light off / on 3 times in a quick succession at the wall switch. After a short time, the light will start to flash.

3.1.4 The light is then displayed in the app. If necessary, update the app by swiping downwards on the screen. Tap on "Add" and follow the steps in the app.

Attention:
Your WLAN ceiling light can only be connected to 2.4 Ghz networks!

3.2 Manual pairing

3.2.1 Make sure that there is sufficient WLAN coverage to connect the devices.
The closer the fixture is to the router, the faster and more secure the process will be.

3.2.2 Open the app and log in.

3.2.3 In the app, click on the PLUS at the top right to add a device.

3.2.4 Select the category "Lighting" and tap on "Ceiling light (Wi-Fi)". Now follow the steps in the app.

DE

1. App installieren

Suchen Sie im App-Store oder im Google Play Store nach der App Tuya Smart und installieren diese auf Ihrem Gerät oder scannen Sie den jeweiligen QR Code hier:

Play Store



App Store



2.Registrierun

Öffnen Sie die App, tippen Sie auf Registrierung und folgen Sie den Anweisungen in der APP.

3. Gerät in der App hinzufügen

3.1 Verwenden der automatischen Verbindungsfunktion

- 3.1.1 Stellen Sie sicher, dass eine ausreichende WLAN-Abdeckung vorhanden ist, um die Geräte zu verbinden. Je näher die Leuchte am Router ist, desto schneller und sicherer wird der Prozess vollzogen.
- 3.1.2 Öffnen Sie die App und melden Sie sich an.
- 3.1.3 Um die Leuchte in der App hinzuzufügen, muss diese in den Pairing-Modus gebracht werden. Hierfür schalten Sie die Leuchte am Wandschalter 3-mal kurz nacheinander aus / an. Die Leuchte fängt nun nach kurzer Zeit an, zu blinken.
- 3.1.4 Nach kurzer Zeit wird Ihnen die Leuchte in der App angezeigt. Aktualisieren Sie gegebenenfalls die App, indem Sie auf dem Bildschirm nach unten wischen. Tippen Sie auf „Hinzufügen“ und folgen den Schritten in der App.

HINWEIS:

Ihre WLAN Deckenleuchte kann nur mit 2,4 Ghz Netzwerken verbunden werden!

3.2Manuelle Kopplung

- 3.2.1 Stellen Sie sicher, dass eine ausreichende WLAN-Abdeckung vorhanden ist, um die Geräte zu verbinden. Je näher die Leuchte am Router ist, desto schneller und sicherer wird der Prozess vollzogen.
- 3.2.2 Öffnen Sie die App und melden Sie sich an.
- 3.2.3 Klicken Sie in der App oben rechts auf das PLUS, um ein Gerät hinzuzufügen.
- 3.2.4 Wählen Sie die Kategorie „Beleuchtung“ aus und tippen Sie auf „Deckenleuchte (Wi-Fi)“.
Folgen Sie nun den Schritten in der App.

FR

1. Installation de l'application

Recherchez l'application Tuya Smart dans l'App Store ou Google Play Store et installez-la sur votre appareil ou scannez le code QR correspondant ici :

Play Store

App Store



2. Inscription

Ouvrez l'application et suivez les instructions.

3. Connectez-vous avec l'application

3.1 Connexion automatique

3.1.1 Assurez-vous que la couverture WLAN est suffisante pour connecter les appareils. Plus le luminaire est proche du routeur, plus le processus sera rapide et sécurisé.

3.1.2 Ouvrez l'application et connectez-vous.

3.1.3 Pour ajouter le luminaire dans l'application, il doit être mis en mode appairage. Pour ce faire, éteignez / allumez la lumière 3 fois de suite au niveau de l'interrupteur mural. Après un court instant, le voyant commence à clignoter.

3.1.4 La lumière est alors affichée dans l'application. Si nécessaire, mettez à jour l'application en glissant vers le bas sur l'écran. Appuyez sur "Ajouter" et suivez les étapes dans l'application.

Attention:

Votre plafonnier WLAN ne peut être connecté qu'aux réseaux 2,4 Ghzi

3.2 Appairage manuel

3.2.1 Assurez-vous que la couverture WLAN est suffisante pour connecter les appareils. Plus le luminaire est proche du routeur, plus le processus sera rapide et sécurisé.

3.2.2 Ouvrez l'application et connectez-vous.

3.2.3 Dans l'application, cliquez sur le PLUS en haut à droite pour ajouter un appareil

3.2.4 Sélectionnez la catégorie "Éclairage" et appuyez sur "Plafonnier (Wi-Fi)". Suivez maintenant les étapes dans l'application.