

## Reeds

design  
Klaus Begasse

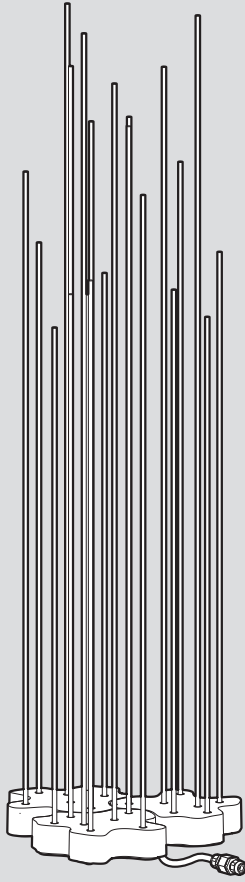

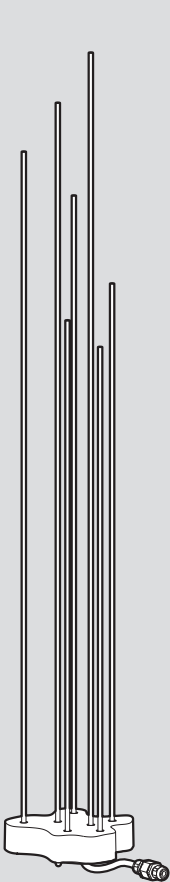

i

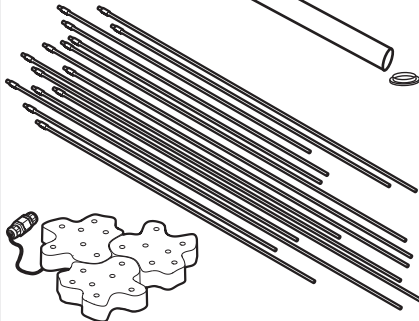
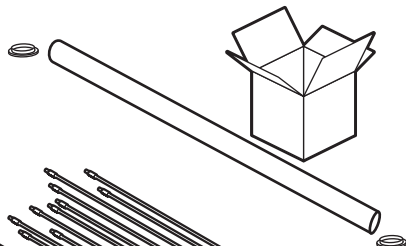
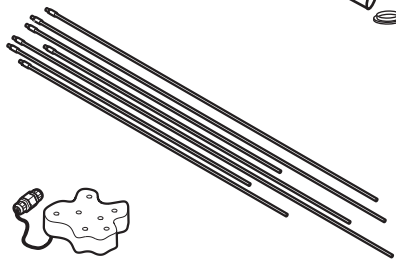
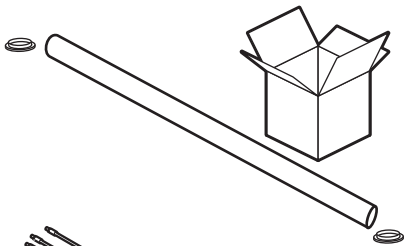
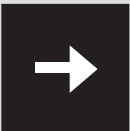
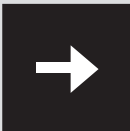
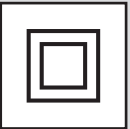

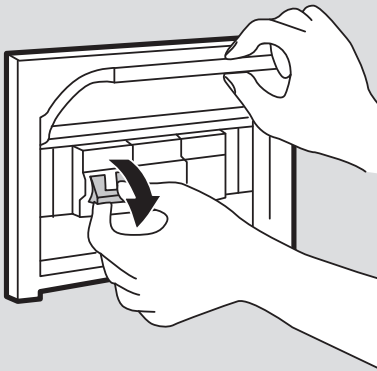

1

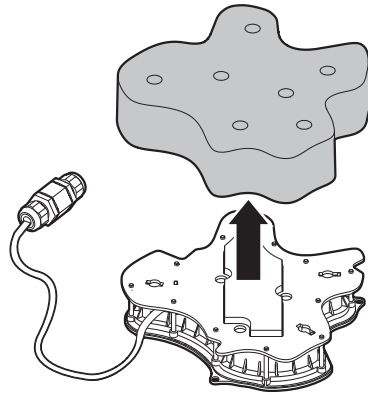

2

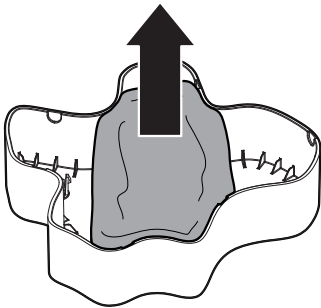

3

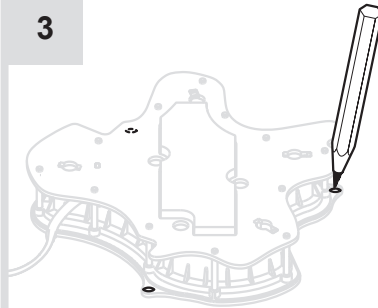

4

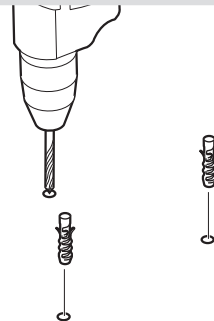

5a

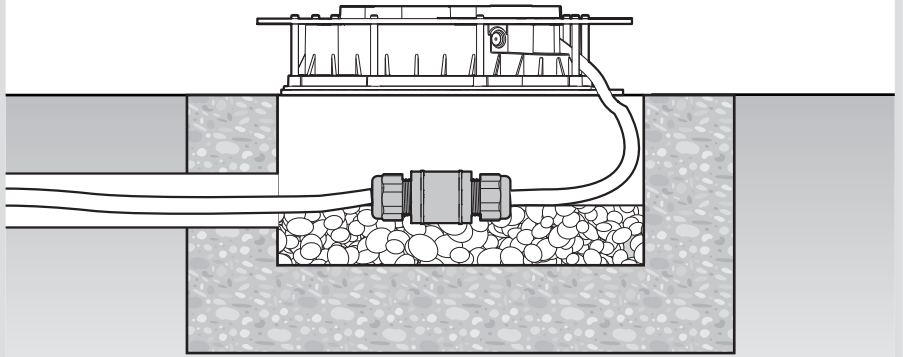

5b

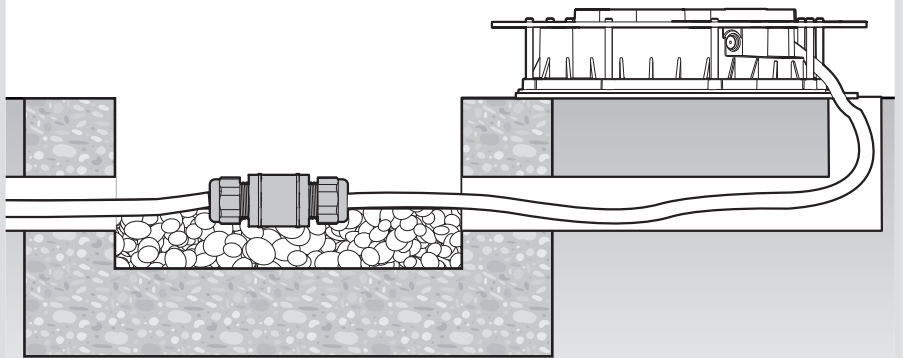

6

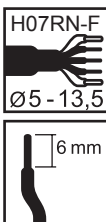
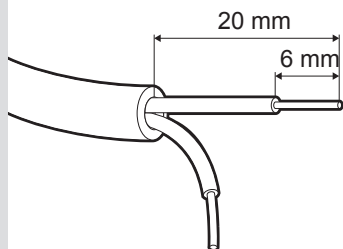

7

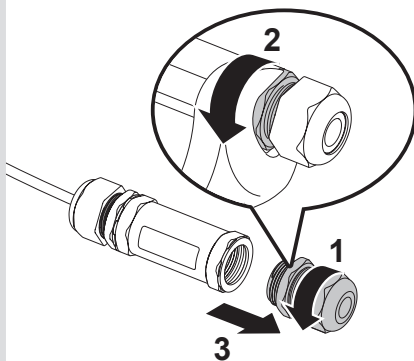

8

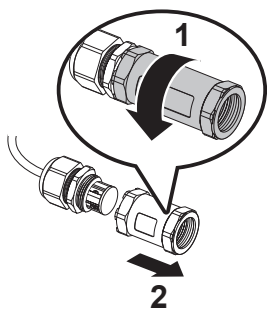

9

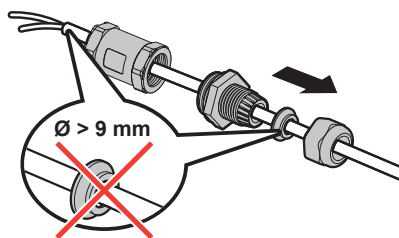

10

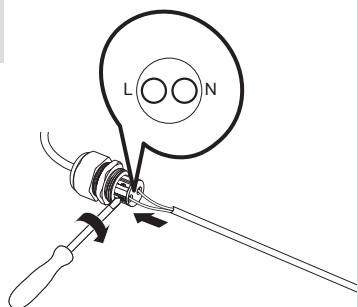

11

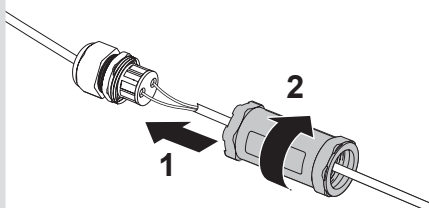

12

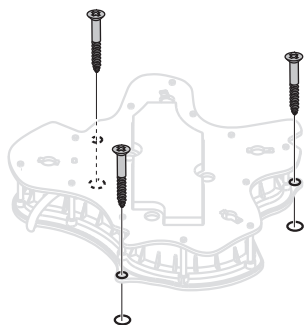

13

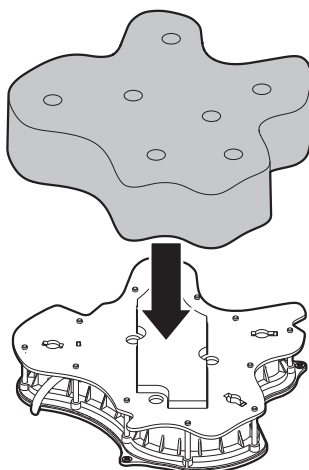

14

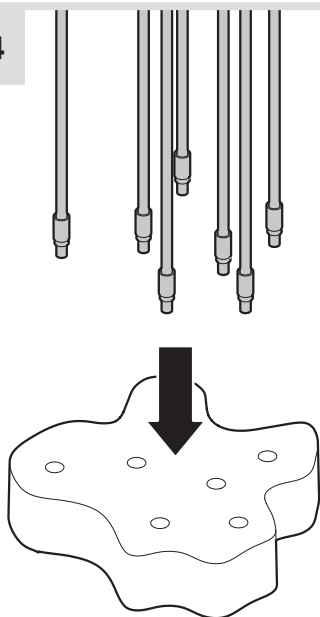

15

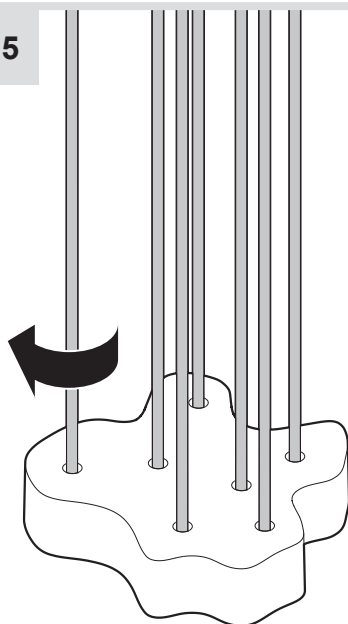

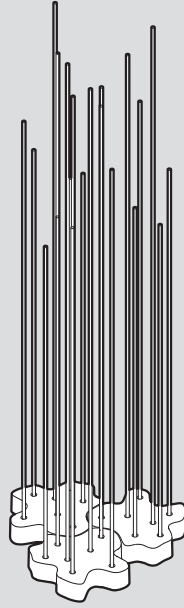

**i**

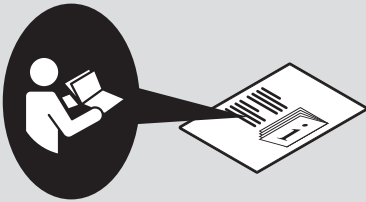

**1**



**Artemide®**



## **Artemide**

via Bergamo, 18  
20010 Pregnana M.se (MI)  
ITALIA

tel. +39 02 935 181  
fax +39 02 935 90 254  
fax +39 02 935 90 496

[www.artemide.com](http://www.artemide.com)

VAT IT00846890150

cod. Y513000103A