

30702

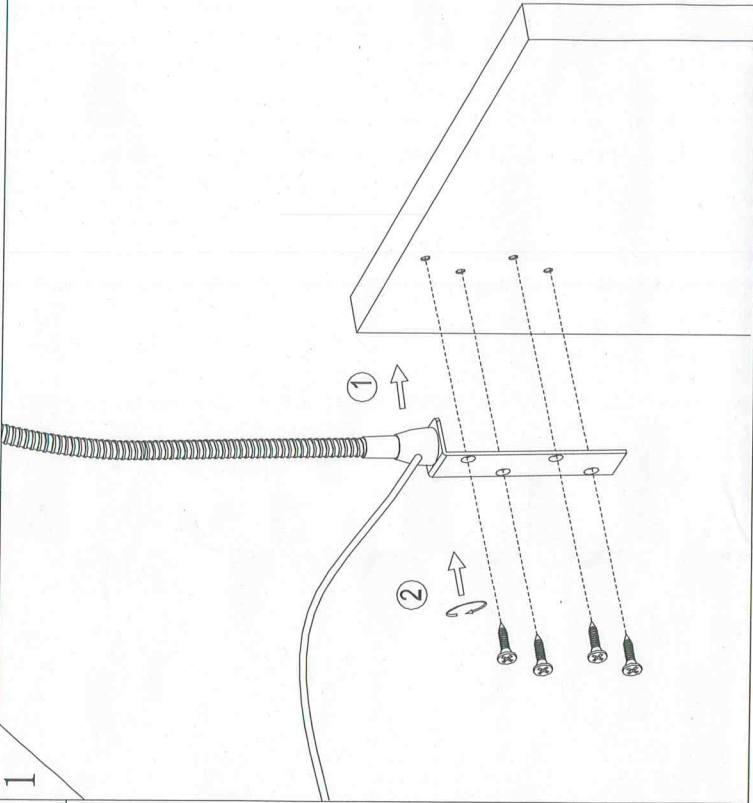

x 4

1

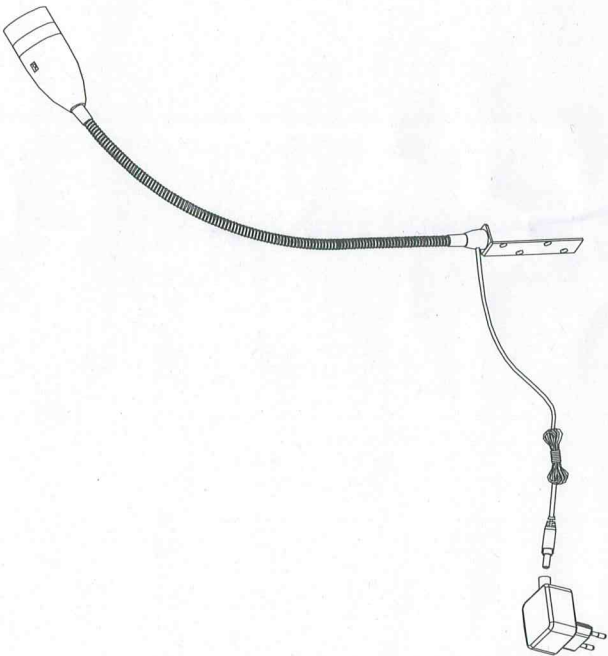

2

3

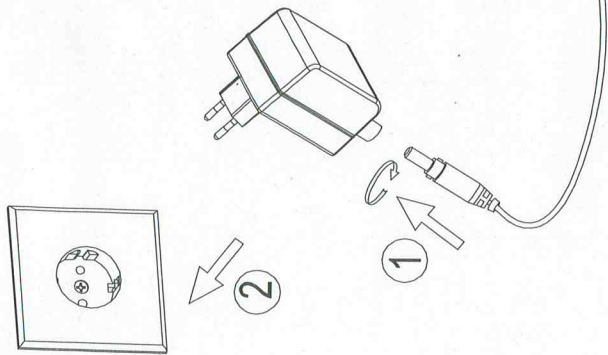

4

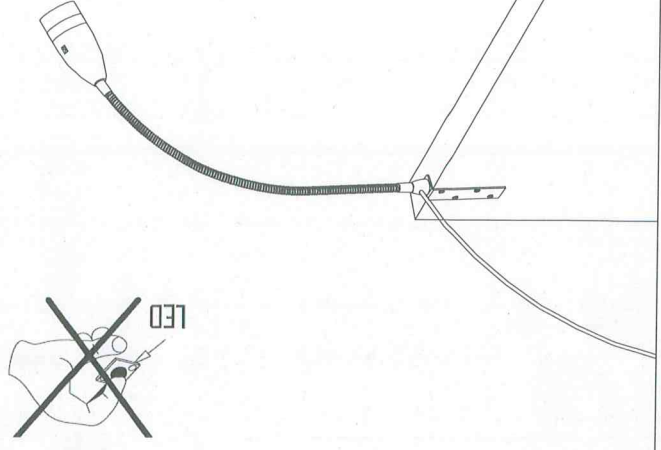
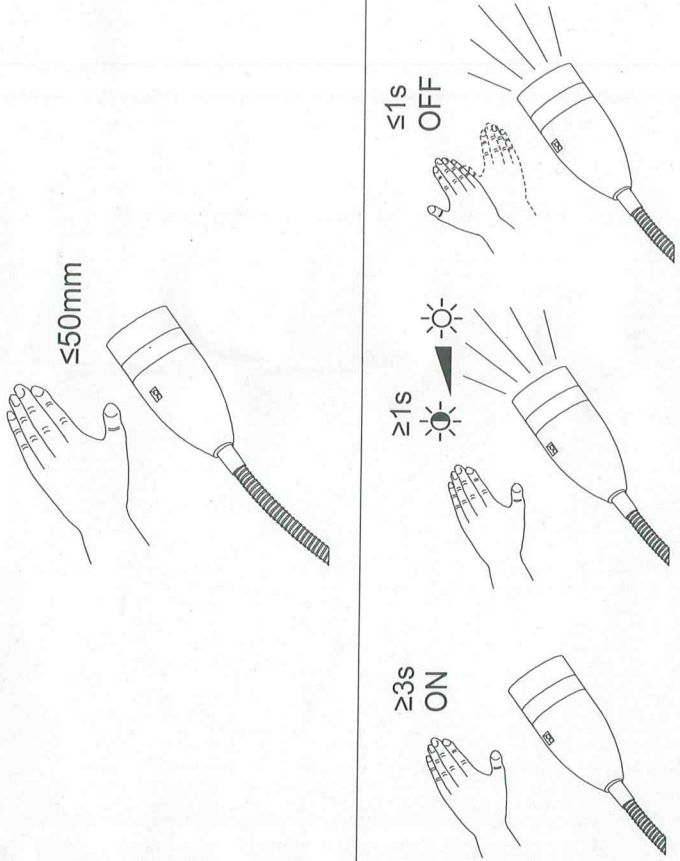

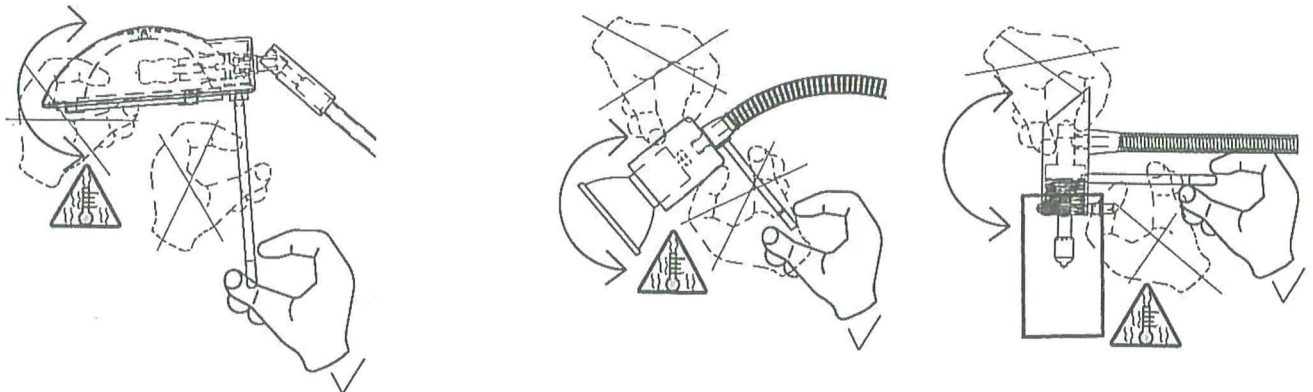
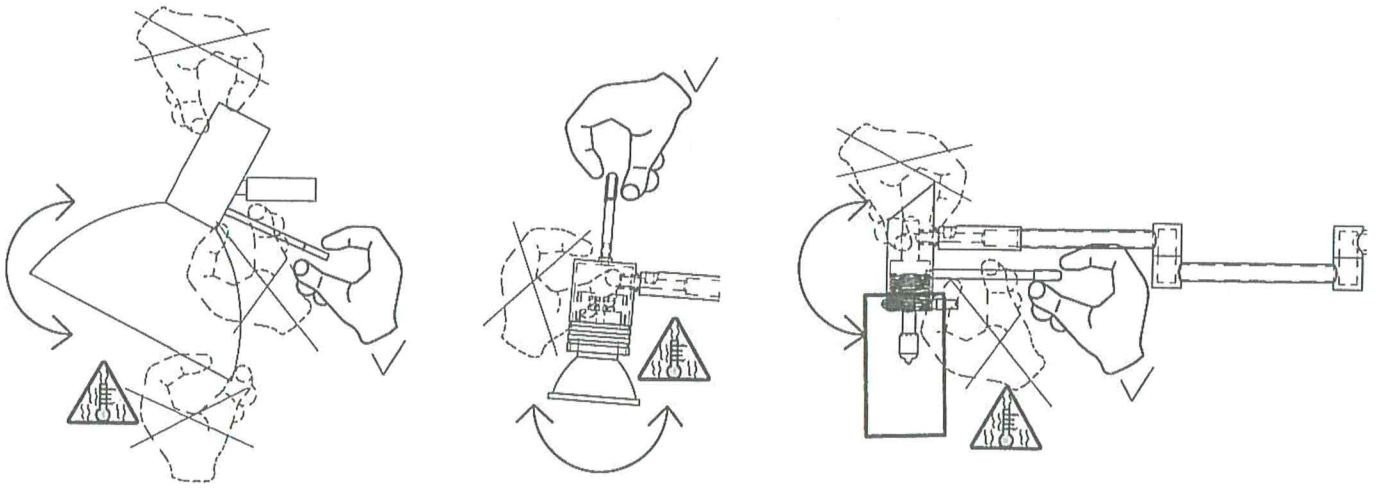
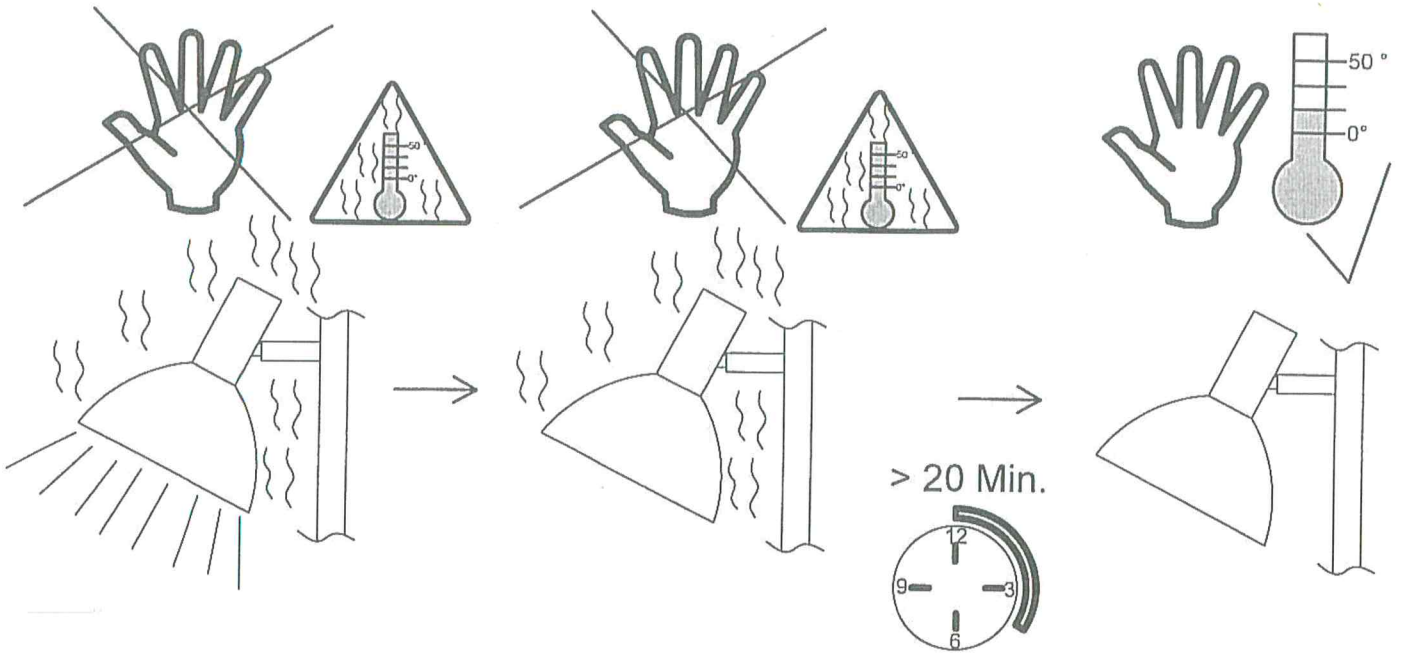

ACHTUNG!

Diese Leuchte entspricht der Schutzklasse III und ist ausschließlich für den Anschluss mittels des mitgelieferten Steckernetzteils an 230V AC, 50Hz, zugelassen.

ATTENTION!

This lamp is in compliance with safety class III and has only been approved for the connection to 230V AC / 50 Hz with the delivered wall power supply.