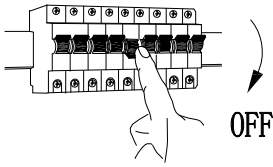
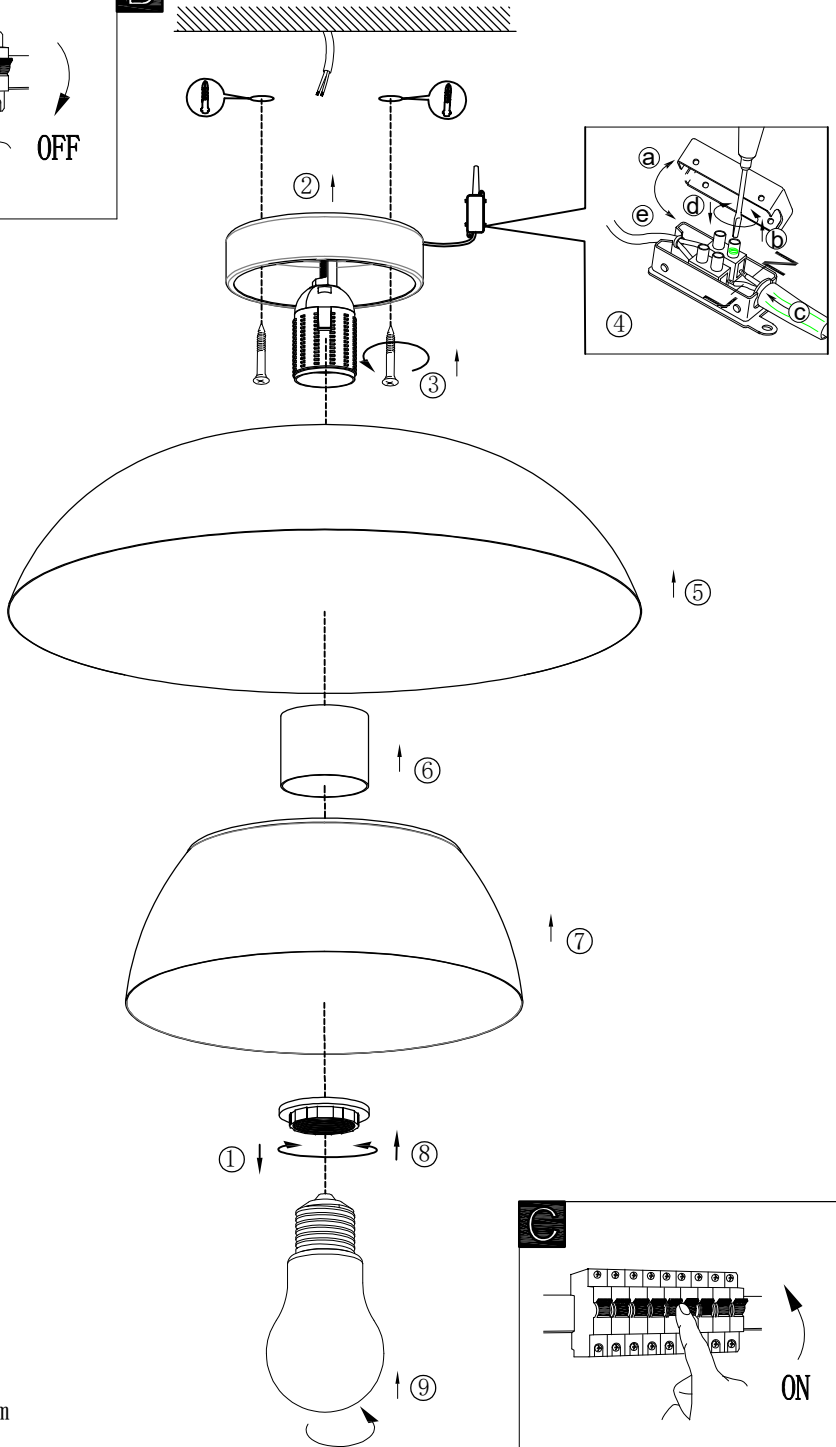
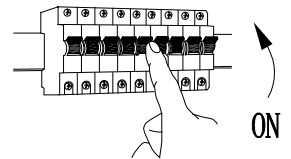

A**B****C**

B900848
www.eglo.com