

## 9626107

11W LED

Incl. LED Board: L9001744

230V ~ 50Hz



### (DE) Bestimmungsgemäße Verwendung

(GB) Intended use / (FR) Utilisation conforme / (NL) Beoogd gebruik / (PL) Stosowanie zgodnie z przeznaczeniem / (NO) Riktig bruk / (DK) Korrekt brug / (SE) Avsedd användning / (FI) Määräystenmukainen käyttö

(IT) Impiego appropriato / (ES) Uso prescrito / (CZ) Použití v souladu s určením / (PT) Utilização correta / (GR) Ενδειγμένη χρήση

(DE)	Ortsfeste Verwendung als Bilderleuchte im Innenbereich	(GB)	Provided for stationary use as picture light, indoors
(FR)	En tant qu'applique tableau, à l'intérieur	(NL)	Vast gebruik als schilderijverlichting binnenshuis
(PL)	Do montażu stacjonarnego jako oświetlenie obrazów do wnętrz	(NO)	Til stasjonært bruk som billedlampe innendørs
(DK)	Til stationær brug som billedlampe indendørs	(SE)	Används som fast tavelbelysning inomhus
(FI)	Kiinteä käyttö sisätilojen tauluvalaisimena	(IT)	Impiego fisso come lampada per quadri in ambienti interni
(ES)	Empleo fijo en tanto lámpara de cuadros en interiores	(CZ)	Stacionární použití jako osvětlení obrazů v interiéru
(PT)	Aplicação fixa como luminária para quadros em interiores	(GR)	Σταθερή χρήση ως φωτιστικό κάδρου σε εσωτερικό χώρο

### (DE) Verwendete Symbole

(GB) Safety Precautions / (FR) Symboles utilises / (NL) Gebruikte symbolen / (PL) Stosowane symbole / (NO) Brukte symboler / (DK) Brugte symboler / (SE) Använda symboler / (FI) Käytetyt symbolit / (IT) Simboli usati / (ES) Símbolos empleados / (CZ) Použité symboly / (PT) Símbolos utilizados / (GR) Χρησιμοποιούμενα σύμβολα

IP 20



### (DE) Lieferumfang

(GB) Package contents / (FR) Contenu de la livraison / (NL) Bij de levering inbegrepen / (PL) Zakres dostawy / (NO) Levering / (DK) Leveringsomfang / (SE) Leveransomfattning / (FI) Toimitussisältö / (IT) Fornitura / (ES) Volumen de suministro / (CZ) Rozsah dodávky / (PT) Material fornecido / (GR) Παραδοτέος εξοπλισμός

(DE)	1 Bilderleuchte Montagematerial Montageanleitung	(GB)	1 Picture light Installation hardware Mounting instructions	(FR)	1 Applique tableau Matériel de montage Instructions de montage
(NL)	1 Schilderijverlichting Monteringsmateriale Montagehandleiding	(PL)	1 Oświetlenie obrazów Elementy montażowe Instrukcja montażu	(NO)	1 Billedlampe Monteringsmateriale Brukerveiledning
(DK)	1 Billedlampe Monteringsmateriale Brugervejledning	(SE)	1 Tavelbelysning Monteringsmaterial Monteringsanvisning	(FI)	1 Tauluvalaisin Asennusmateriaali Asennusohjeet
(IT)	1 Lampada per quadri Materiale di montaggio Istruzioni di montaggio	(ES)	1 Lámpara de cuadros Material de montaje Instrucciones de montaje	(CZ)	1 Osvětlení obrazů Materiál pro montáž Návod k montáži
(PT)	1 Luminária para quadros Material de montagem Instruções de montagem	(GR)	1 Φωτιστικό κάδρου Υλικό συναρμολόγησης Οδηγίες συναρμολόγησης		

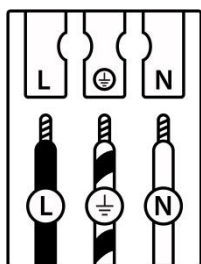
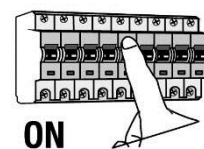
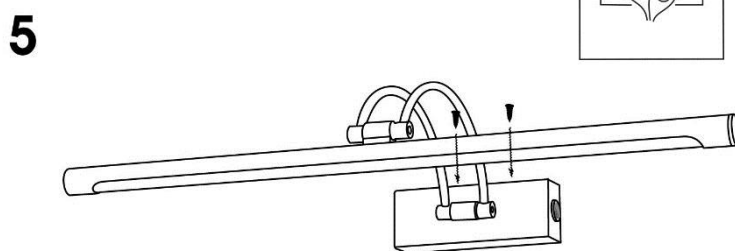
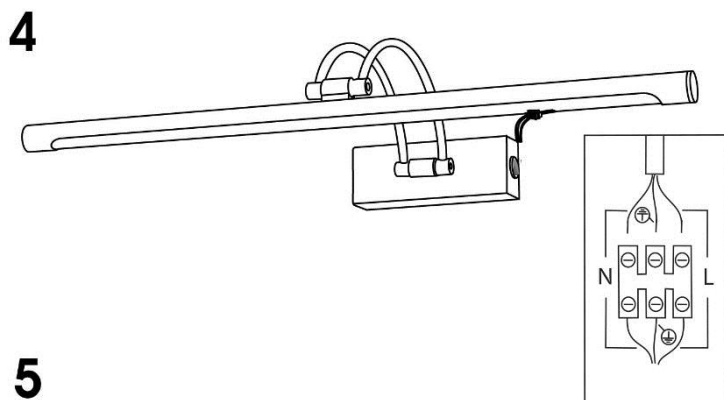
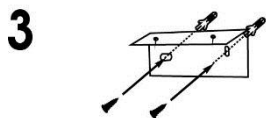
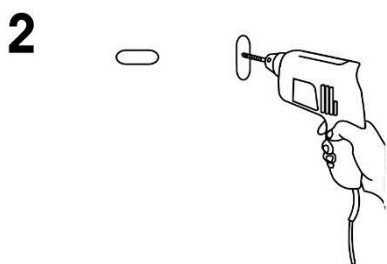
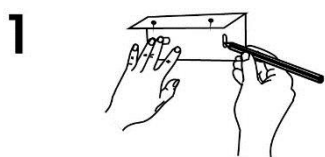

	(DE)	(GB)	(FR)	(NL)	(PL)	(NO)	(DK)
<b>L</b>	Stromführender Leiter	Live conductor	Conducteur	Spanningvoerende draad	Przewód prądowy	Strømførende leder	Strømførende leder
	Schutzleiter	Earth conductor	Conducteur de protection (terre)	Aardkabel	Przewód uziemiający	Jordledningen	Jordledningen
<b>N</b>	Neutralleiter	Neutral conductor	Conducteur neutre	Nulleider	Przewód zerowy	Nøytralleder	Neutralleder

	(SE)	(FI)	(IT)	(ES)	(CZ)	(PT)	(GR)
<b>L</b>	Strömförande ledare	Virtajohdin	Conduttore sotto tensione	Líneas conductoras de corriente	Vodič pod napětím	Condutor vivo	Ρευματοφόρος αγωγός
	Skyddsledare	Suojajohdin	Conduttore di terra	Conductor de protección	Ochranný vodič	Condutor de terra	Αγωγός γείωσης
<b>N</b>	Neutralledare	Nollajohdin	Conduttore neutro	Conductor neutro	Neutrální vodič	Condutor neutro	Ουδέτερος αγωγός

<p><b>(DE)</b> Dieses Produkt enthält eine Lichtquelle der Energieeffizienzklasse E  <b>(EN)</b> This product contains a light source of energy efficiency class E  <b>(FR)</b> Ce produit comprend une source de lumière de classe d'efficacité énergétique E  <b>(NL)</b> Dit product bevat een lichtbron van energie-efficiëntieklasse E  <b>(PL)</b> Produkt ten zawiera źródło światła o klasie efektywności energetycznej E  <b>(NO)</b> Dette produktet inneholder en lyskilde i energieeffektivitetsklasse E  <b>(DK)</b> Dette produkt indeholder en lyskilde af energieeffektklasse E  <b>(SE)</b> Denna produkt innehåller en ljuskälla i energieffektivitetsklass E  <b>(FI)</b> Tämä tuote sisältää energiatehokkuusluokan E valonlähteen  <b>(IT)</b> Questo prodotto contiene una sorgente luminosa della classe di efficienza energetica E  <b>(ES)</b> Este producto contiene una fuente de luz de la clase de eficiencia energética E  <b>(CZ)</b> Tento výrobek obsahuje světelný zdroj třídy energetické účinnosti E  <b>(PT)</b> Este produto contém uma fonte de luz da classe de eficiência energética E  <b>(GR)</b> Αυτό το προϊόν περιέχει μια φωτεινή πηγή ενεργειακής απόδοσης κλάσης E  <b>(SK)</b> Tento výrobok obsahuje zdroj svetla triedy energetickej efektivity E</p>	<p><b>QR</b></p> 	<p><b>EAN</b></p> <p>4251911725803</p>
---	--	--

	<p><b>(DE)</b> Durch einen Fachmann austauschbare Lichtquelle (nur LED)  <b>(EN)</b> Replaceable (LED only) light source by a professional.  <b>(FR)</b> Source de lumière remplaçable (LED uniquement) par un professionnel.  <b>(NL)</b> Lichtbron (alleen led) te vervangen door een professional.  <b>(PL)</b> Wymienne (tylko LED) źródło światła wykonane przez profesjonalistę.  <b>(NO)</b> Utskiftbar (kun LED) lyskilde av en profesjonell.  <b>(DK)</b> Udskiftelig lyskilde (kun LED), udskiftes af en elektriker.  <b>(SE)</b> Ljuskälla (endast LED) utbytbar genom fackman.  <b>(FI)</b> Ammattilainen voi vaihtaa vaihdettavan (vain LED) valonlähteen.  <b>(IT)</b> Sorgente luminosa (solo LED) sostituibile da un professionista.  <b>(ES)</b> Fuente de luz (solo LED) sustituible por un profesional.  <b>(CZ)</b> Vyměnitelný (pouze LED) světelný zdroj odborníkem.  <b>(PT)</b> Luz LED (apenas LED) substituível por um profissional.  <b>(GR)</b> Η πηγή φωτός (μόνο LED) να αντικαθίσταται από επαγγελματία.  <b>(SK)</b> Zdroj svetla (iba LED) vymeniteľný prostredníctvom odborníka.</p>
--	--

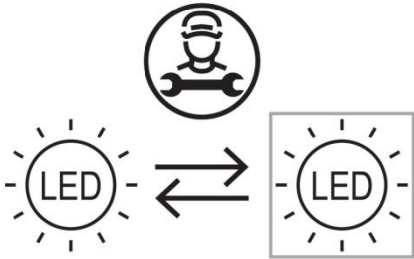
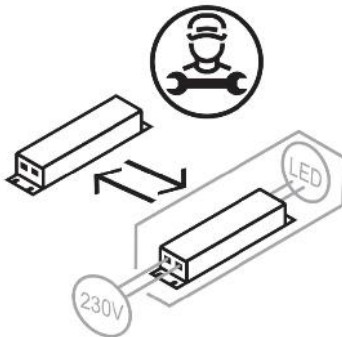
	<p><b>(DE)</b> Durch einen Fachmann austauschbares Betriebsgerät.  <b>(EN)</b> Replaceable control gear by a professional.  <b>(FR)</b> Contrôleur remplaçable par un professionnel.  <b>(NL)</b> Voorschakelapparatuur te vervangen door een professional.  <b>(PL)</b> Wymienny układ sterujący przez profesjonalistę.  <b>(NO)</b> Utskiftbar kontrollutstyr av en profesjonell.  <b>(DK)</b> Udskiftelig igangsætter, udskiftes af en elektriker.  <b>(SE)</b> Styrdon utbytbar genom fackman.  <b>(FI)</b> Ammattilainen voi vaihtaa vaihdettavat ohjauslaitteet.  <b>(IT)</b> Dispositivo di controllo sostituibile da un professionista.  <b>(ES)</b> Dispositivo de control sustituible por un profesional.  <b>(CZ)</b> Vyměnitelný předřadník odborníkem.  <b>(PT)</b> Dispositivo de controlo substituível por um profissional.  <b>(GR)</b> Ο εξοπλισμός ελέγχου να αντικαθίσταται από επαγγελματία.  <b>(SK)</b> Predradník vymeniteľný prostredníctvom odborníka.</p>
---	---