

Artemide®

Gople

design
BIG

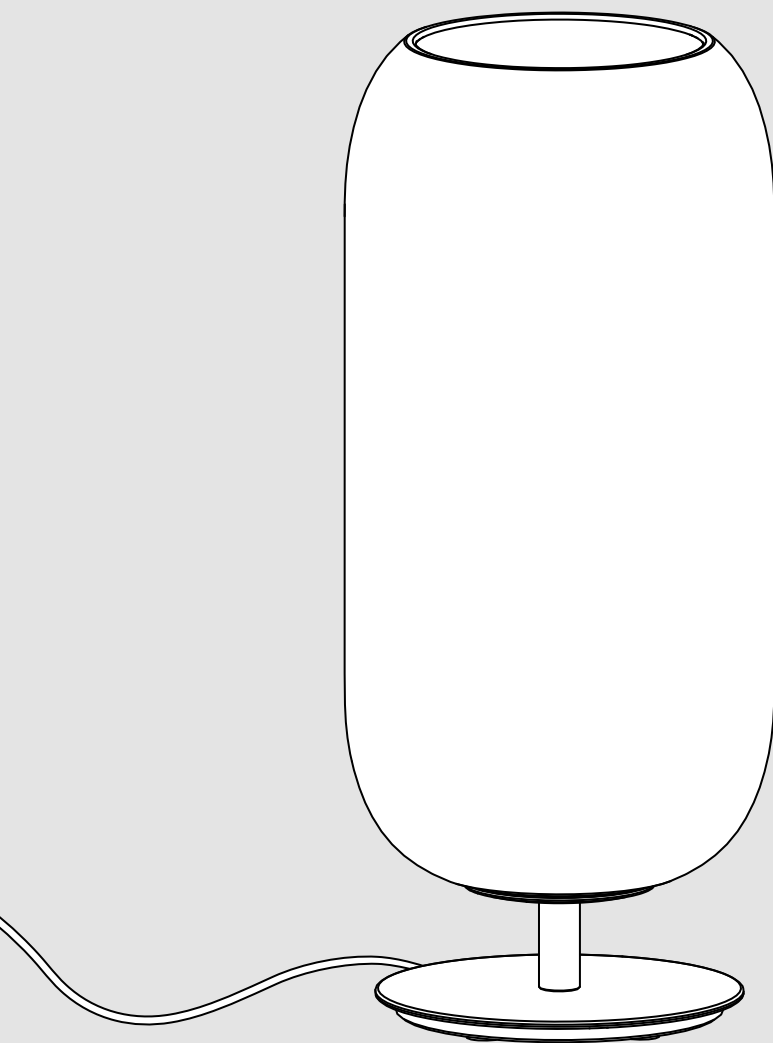



i

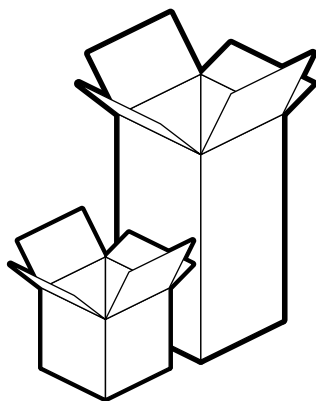
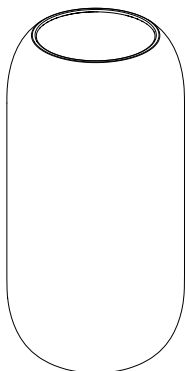
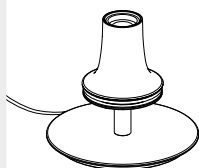
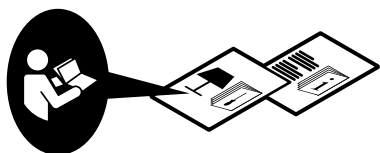
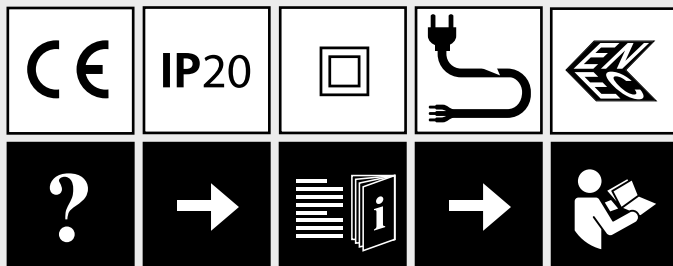

1

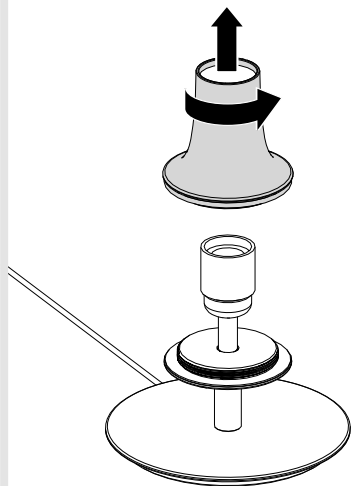

2

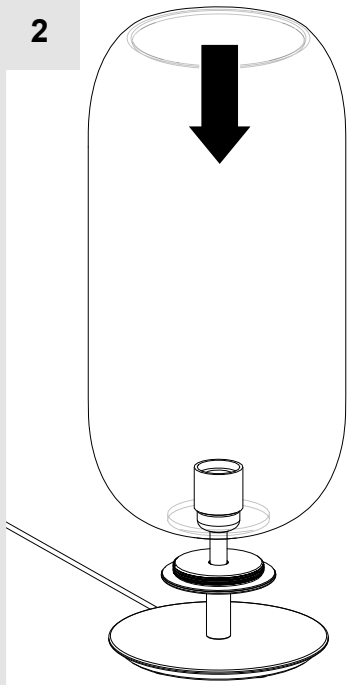

3

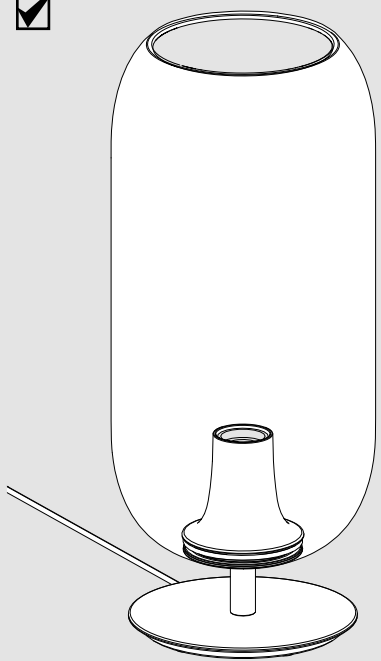
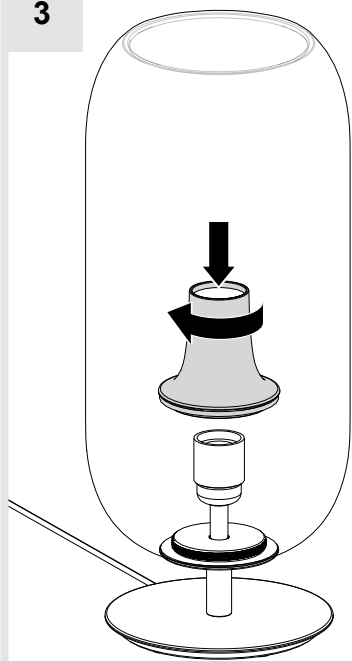

4

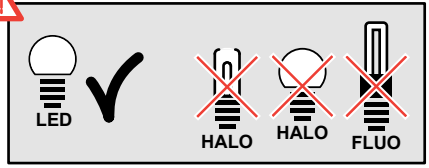
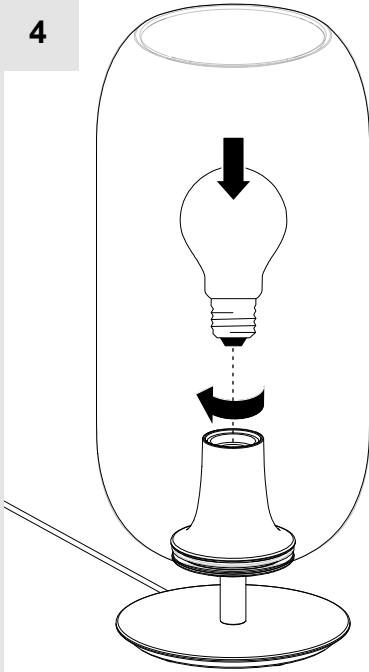

Max 20W LED E27

For USA and Canada only:

Max 22W E26 cULus SBLED



5

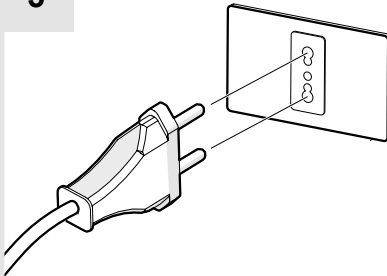

For USA and Canada only

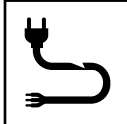
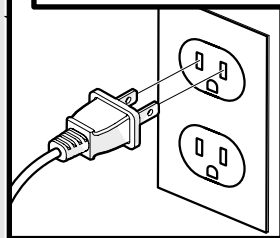

6

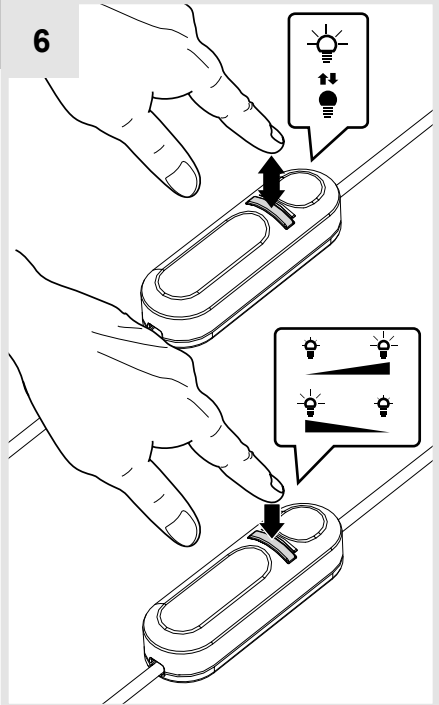

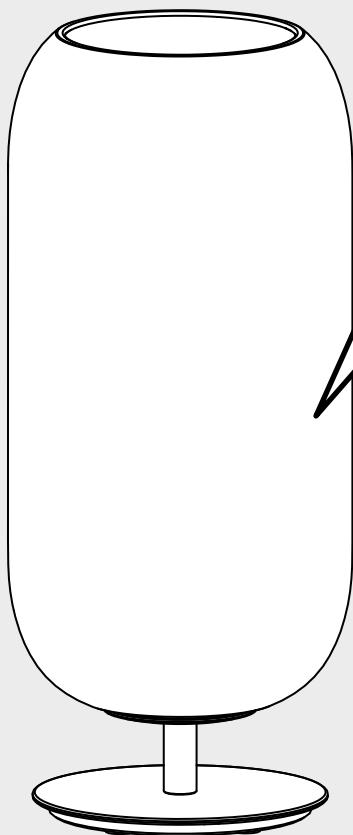

MAX 20W LED E27



For USA and Canada only:
Max 22W E26 cULus SBLED

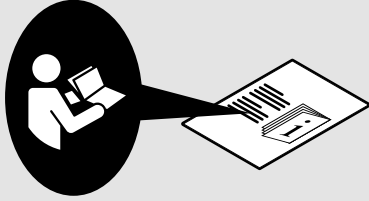

Artemide®

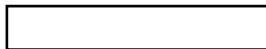

Artemide

via Bergamo, 18
20010 Pregnana M.se (MI)
ITALIA

tel. +39 02 935 181
fax +39 02 935 90 254
fax +39 02 935 90 496

www.artemide.com

VAT IT00846890150

Artemide Inc.

250 Karin Lane
Hicksville, NY 11801

Tel. 631 694 9292
Toll Free 1-877-Art-9111
Fax 631 694 9275

www.artemide.net

Artemide Ltée/Ltd.

11105 rue Renaude Lapointe
Montréal, Québec H1J 2T4

Tel. 514 323 6537
Toll Free 888 777 2783
Fax 514 323 8864

www.artemide.net

cod. Y513001041A