

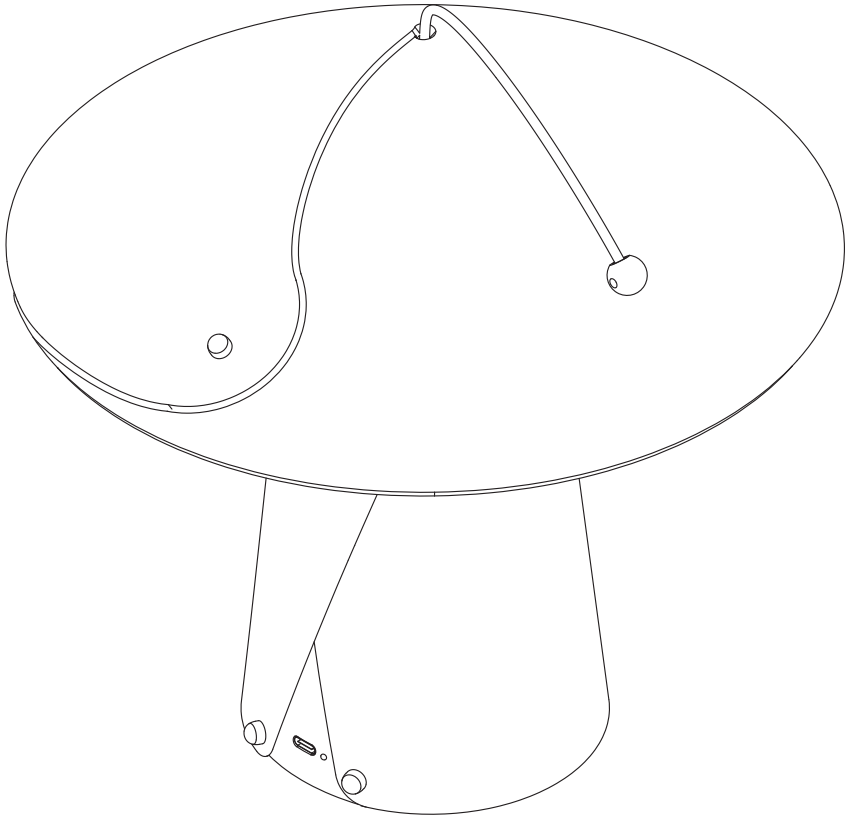

# DECOR FLIP MOBILE TABLE TOUCH-DIM



	EAN	W	W <sub>max.</sub>	Im Light Source	Im Output
DECOR FLIP MOBILE TABLE3.5WTOUCHDIM	4058075848566	3.5	10	240	70

	EAN	K	IP	°C	V~	mA	
DECOR FLIP MOBILE TABLE3.5WTOUCHDIM	4058075848566	3000	20	-20...+40	5	2000	10000

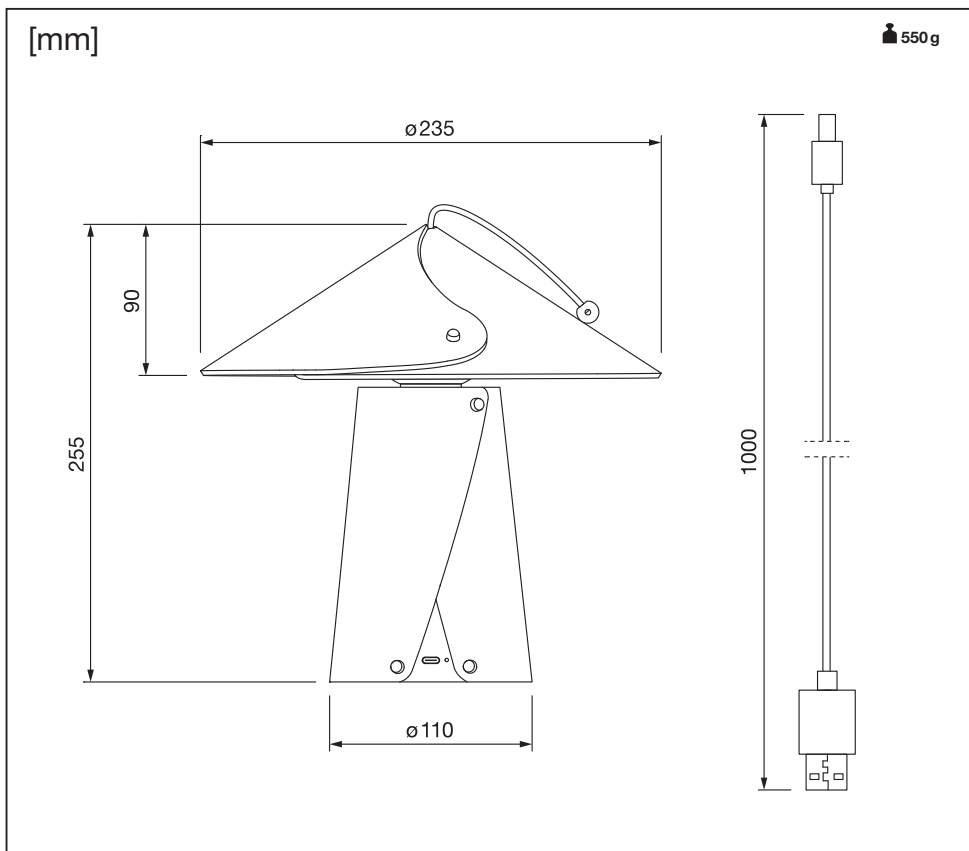
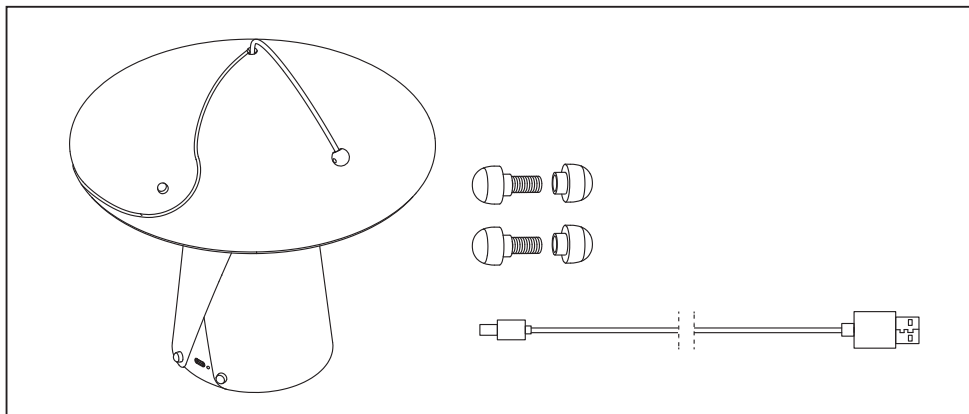

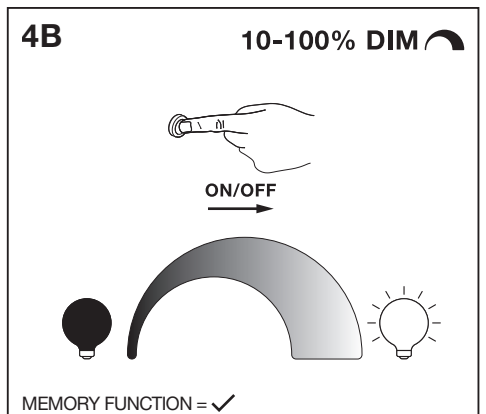
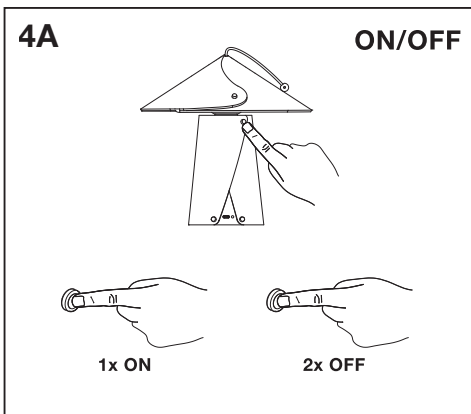
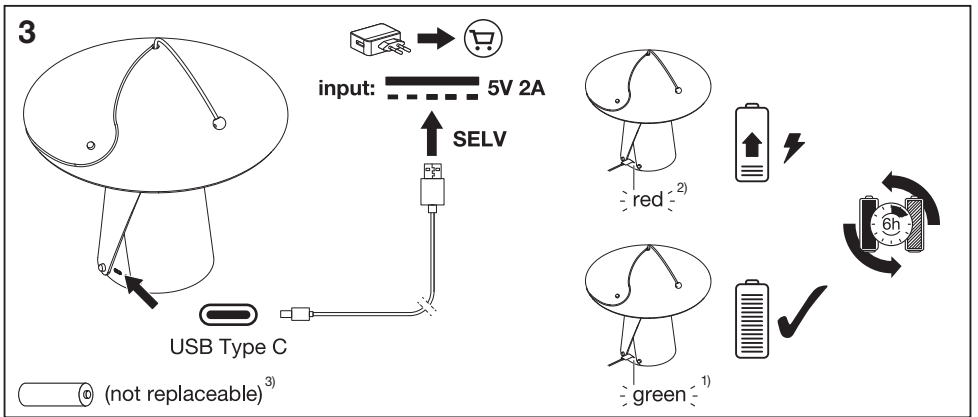
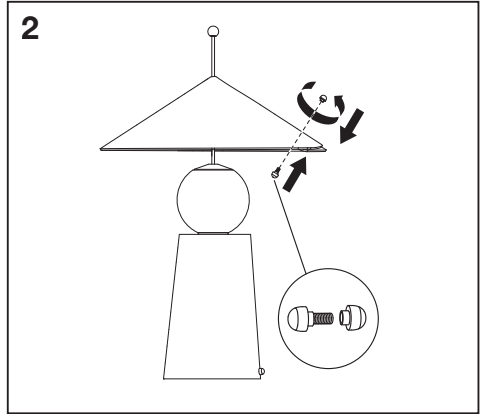
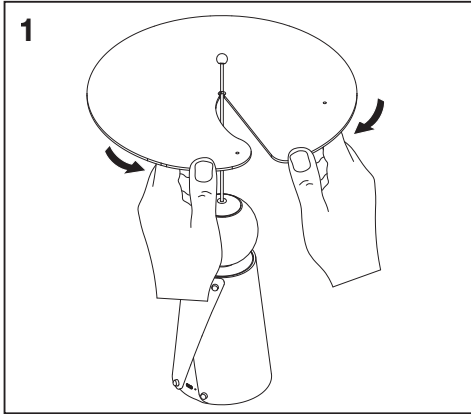

5

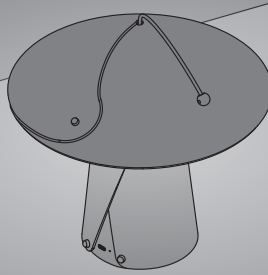

Max.

Ⓢ 1) Grün 2) Rot 3) nicht austauschbar Ⓢ 1) Green 2) Red 3) not replaceable Ⓢ 1) Vert 2) Rouge 3) non remplaçable Ⓢ 1) Verde 2) Rosso 3) non sostituibile Ⓢ 1) Verde 2) Rojo 3) no reemplazable Ⓢ 1) Verde 2) Vermelho 3) não substituível Ⓢ 1) Πράσινο 2) Κόκκινο 3) μη αντικαταστάσιμο Ⓢ 1) Groen 2) Rood 3) niet vervangbaar Ⓢ 1) Grön 2) Röd 3) ej utbytbar Ⓢ 1) Vihreä 2) Punainen 3) ei korvattavissa Ⓢ 1) Grønn 2) Rød 3) ikke utskiftbar Ⓢ 1) Grøn 2) Rød 3) kan ikke udskiftes Ⓢ 1) Zelená 2) Červená 3) nevyměnitelné Ⓢ 1) Зеленый 2) Красный 3) не подлежит замене Ⓢ 1) Zöld 2) Piros 3) nem cserélhető Ⓢ 1) Zielony 2) Czerwony 3) niewymienne Ⓢ 1) Zelený 2) Červený 3) nevymenitelné Ⓢ 1) Zelena 2) Rdeča 3) ni mogoče zamenjati Ⓢ 1) Yeşil 2) Kırmızı 3) değiştirilemez Ⓢ 1) Zeleno 2) Crveno 3) ne može se zamijeniti Ⓢ 1) Verde 2) Roşu 3) nu se poate înlocui Ⓢ 1) Зелен 2) Червен 3) не може да се замени Ⓢ 1) Roheline 2) Punane 3) ei ole asendatav Ⓢ 1) Žalias 2) Raudona 3) nekeičiamas Ⓢ 1) Zaiš 2) Sarkans 3) nav nomaināms Ⓢ 1) Зелено 2) Crveno 3) ne može se zameniti Ⓢ 1) Зелений 2) Червоний 3) не підлягає заміні Ⓢ 1) Жасыл 2) Қызыл 3) ауыстырылмайтын

Points de collecte sur [www.quefairedemesdechets.fr](http://www.quefairedemesdechets.fr)

LEDVANCE SASU  
CQM, 5 rue d'Altorf  
67120 Molsheim France  
[www.ledvance.com](http://www.ledvance.com)

C10449057  
G11220006

28.03.25

Ⓢ LEDVANCE Ltd, Sterling House,  
810 Mandarin Court, Warrington,  
Cheshire, WA1 1GG, United Kingdom