

## 10027026

10W LED / 11W Total  
incl. 1,8x LED Board: L9002974  
48Vdc constant voltage / 0,23A

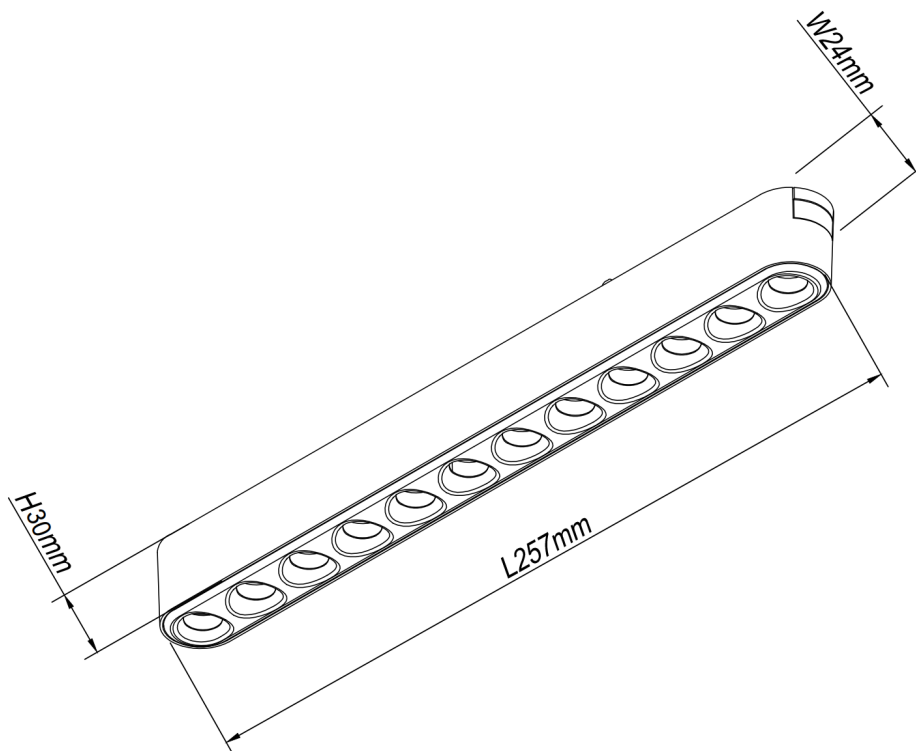





### (DE) Bestimmungsgemäße Verwendung

(EN) Intended use | (FR) Utilisation conforme | (NL) Beoogd gebruik | (PL) Stosowanie zgodnie z przeznaczeniem | (NO) Riktig bruk | (DK) Korrekt brug  
(SE) Avsedd användning | (FI) Määräystenmukainen käyttö | (IT) Impiego appropriato | (ES) Uso prescrito | (CZ) Použití v souladu s určením  
(PT) Utilização correta | (GR) Ενδεικτική χρήση | (SK) Predpokladané použitie | (EE) Eeldatav kasutus | (LV) Paredzamais lietojums  
(LT) Numatomas naudojimas | (RO) Utilizare intenționată | (SI) Predvidena uporaba | (HR) Namjenska upotreba | (HU) Tervezett felhasználás  
(BG) предназначена употреба | (AL) Përdorimi i parashikuar | (MK) Предвидена употреба | (TR) Amaçlı kullanım | (UK) Призначене використання  
(BA,ME,RS) Namjenska upotreba

(DE)	Verwendung als Schienenstrahler im Innenbereich	(GB)	For use indoors as a track spotlight
(FR)	Utilisation comme spot sur rail à l'intérieur	(NL)	Gebruik als railstraler binnenshuis
(PL)	Do montażu jako reflektor szynowy do wnętrza	(NO)	Til bruk som skinnespot innendørs
(DK)	Til brug som strømskinne spot indendørs	(SE)	Används som skenspotlight inomhus
(FI)	Kohdevalaisin 1-vaihejärjestelmään	(IT)	Impiego fisso come spot per binario in ambienti interni
(ES)	Empleo fijo en tanto sistema de riel spot en interiores	(CZ)	Stacionární použití jako reflektor v interiéru
(PT)	Aplicação fixa como holofotes trilha em interiores	(GR)	Σταθερή χρήση ως φωτιστικό οροφής σε εσωτερικό χώρο
(SK)	Na použitie v interiéri ako reflektor	(BG)	За използване на закрито като прожектор за писта
(EE)	Kasutamiseks siseruumides rajavalgustina	(LV)	Izmantošanai iekštelpās kā starmešu prožektoru
(LT)	Naudoti patalpose kaip bėgių prožektorių	(RO)	Pentru utilizare în interior ca reflector pentru șine
(SI)	Za uporabo v zaprtih prostorih kot žaromet za progo	(HR)	Za upotrebu u zatvorenom prostoru kao reflektor za stazu
(HU)	Beltéri használatra sávfényezőként	(AL)	Për përdorim brenda si një dritë ndjekëse
(MK)	За употреба внатре како светилка за следење	(TR)	İç mekanda bir ray spot ışığı olarak kullanım
(UK)	Для використання всередині як прожектор для треку	(BA)	Za upotrebu unutra kao svjetiljka za praćenje
		(ME)	
		(RS)	

(DE) Lieferumfang		
(EN) Package contents   (FR) Contenu de la livraison   (NL) Bij de levering inbegrepen   (PL) Zakres dostawy   (NO) Levering   (DK) Leveringsomfang (SE) Leveransomfattning   (FI) Toimitussisältö   (IT) Fornitura   (ES) Volumen de suministro   (CZ) Rozsah dodávky   (PT) Material fornecido (GR) Παράδοτος εξοπλισμός   (SK) Obsah balenia   (EE) Pakendi sisu   (LV) Pakas saturs   (LT) Pakuotės turinys (RO) Conținutul pachetului   (SI) Vsebina paketa   (HR) Sadržaj paketa   (HU) A csomag tartalma   (BG) обхват на доставката (AL) Përmbajtja e dorëzimit   (MK) Содржина на испорака   (TR) Teslimat içeriği   (UK) Зміст доставки   (BA,ME,RS) Sadržaj isporuke		
(DE) 1 Schienenstrahler Montagematerial Montageanleitung	(GB) 1 track spotlight Installation hardware Mounting instructions	(FR) 1 spot sur rail Matériel de montage Instructions de montage
(NL) 1 railstraler Monteringsmateriale Montagehandleiding	(PL) 1 reflektor szynowy Elementy montażowe Instrukcja montażu	(NO) 1 skinnespot Monteringsmateriale Brukerveiledning
(DK) 1 strømskinne spot Monteringsmateriale Brugervejledning	(SE) 1 skenspotlight Monteringsmaterial Monteringsanvisning	(FI) 1 Kohdevalaisin Asennus materiaali Asennusohjeet
(IT) 1 spot per binario Materiale di montaggio Istruzioni di montaggio	(ES) 1 sistema de riel spot Material de montaje Instrucciones de montaje	(CZ) 1 Stropní svítidlo Materiál pro montáž Návod k montáži
(PT) 1 Luminária de teto Material de montagem Instruções de montagem	(GR) 1 Φωτιστικό οροφής Υλικό συναρμολόγησης Οδηγίες συναρμολόγησης	(SK) 1 reflektor na trati Inštalčný hardvér Inštalčná príručka
(BG) 1 прожектор за писта материали за монтаж инструкции за монтаж	(EE) 1 kohtvalgusti Paigaldustarvikud Paigaldusjuhend	(LV) 1 sliežu prožektors Instalācijas aparātūra Uzstādīšanas instrukcija
(LT) 1 takelio prožektorius Montavimo aparatinė įranga Montavimo instrukcija	(RO) 1 spot cu șină Hardware de instalare Instrucțiuni de montare	(SI) 1 reflektorska svetilka na stezi Namestitvena strojna oprema Navodila za montažo
(HR) Reflektor za 1 stazu Instalacijski hardver Upute za montažu	(HU) 1 sínes reflektor Telepítési hardver Szerelési útmutató	(AL) 1 dritë fokusimi për rrugë Materiali i montimit Udhëzuesi i montimit
(MK) 1 светилка за патека Монтажен материјал Упатство за монтажа	(TR) 1 raylı spot ışık Montaj malzemesi Montaj kılavuzu	(UK) 1 прожектор для треку Монтажний матеріал Інструкція з монтажу
(BA) 1 reflektor za stazu (ME) Montažni materijal (RS) Uputstvo za montažu		

(DE) Verwendete Symbole	
(EN) Safety Precautions   (FR) Symboles utilisés   (NL) Gebruikte symbolen   (PL) Stosowane symbole   (NO) Brukte symboler   (DK) Brugte symboler (SE) Använda symboler   (FI) Käytetyt symbolit   (IT) Simboli usati   (ES) Símbolos empleados   (CZ) Použité symboly   (PT) Símbolos utilizados (GR) Χρησιμοποιούμενα σύμβολα   (SK) Bezpečnostné opatrenia   (EE) Ohutusabinõud   (LV) Drošības pasākumi (LT) Saugos priemonės   (RO) Măsuri de precauție   (SI) Varnostni ukrepi   (HR) Mjere opreza   (HU) Használt szimbólumok   (BG) Мерки за безопасност (AL) Simbolet e përdorura   (MK) Користени симболи   (TR) Kullanılan semboller   (UK) Використовувані символи   (BA,ME,RS) Korišteni simboli	
IP 20	   

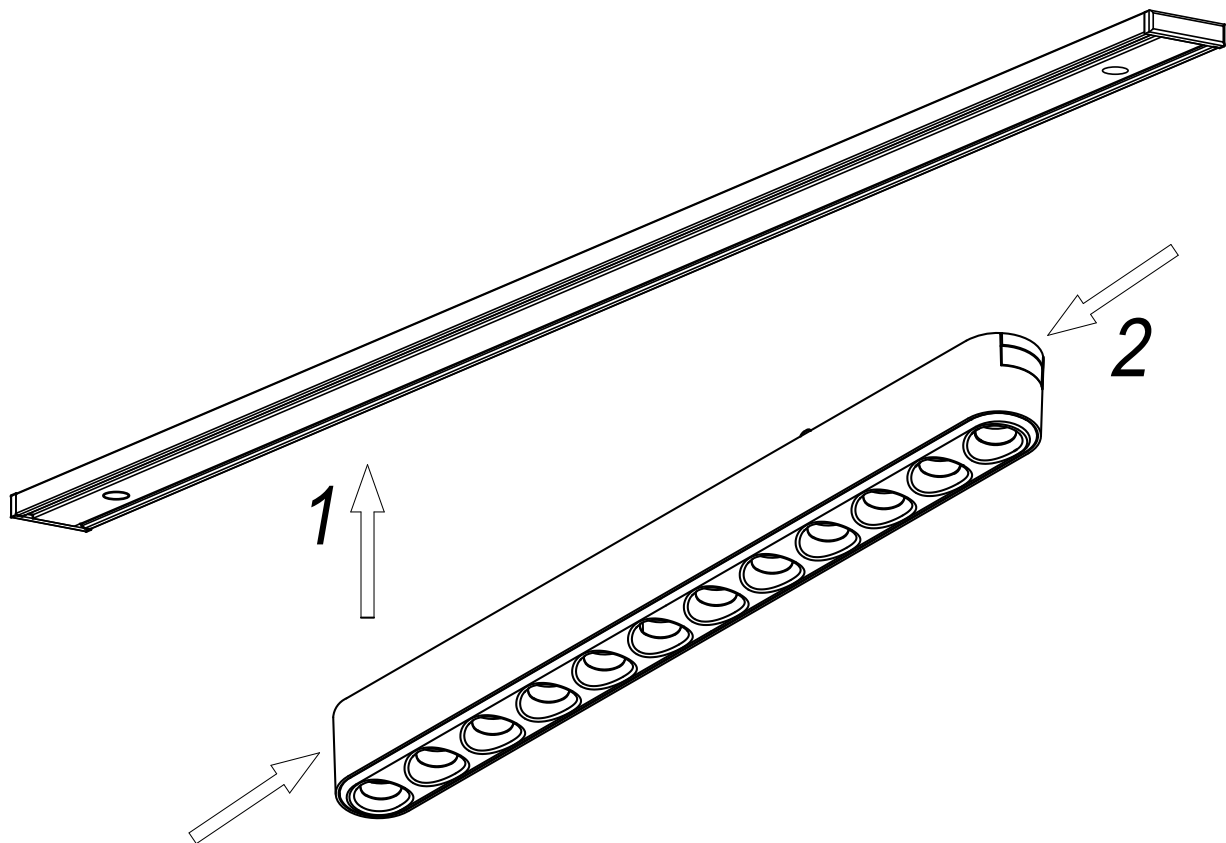

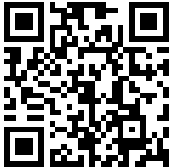
<p>(DE) Dieses Produkt enthält eine Lichtquelle der Energieeffizienzklasse F          (EN) This product contains a light source of energy efficiency class F          (FR) Ce produit comprend une source de lumière de classe d'efficacité énergétique F          (NL) Dit product bevat een lichtbron van energie-efficiëntieklasse F          (PL) Produkt ten zawiera źródło światła o klasie efektywności energetycznej F          (NO) Dette produktet inneholder en lyskilde i energieeffektivitetsklasse F          (DK) Dette produkt indeholder en lyskilde af energieeffektklasse F          (SE) Denna produkt innehåller en ljuskälla i energieeffektivitetsklass F          (FI) Tämä tuote sisältää energiatehokkuusluokan F valonlähteen          (IT) Questo prodotto contiene una sorgente luminosa della classe di efficienza energetica F          (ES) Este producto contiene una fuente de luz de la clase de eficiencia energética F          (CZ) Tento výrobek obsahuje světelný zdroj třídy energetické účinnosti F          (PT) Este produto contém uma fonte de luz da classe de eficiência energética F          (GR) Αυτό το προϊόν περιέχει μια φωτεινή πηγή ενεργειακής απόδοσης κλάσης F          (SK) Tento výrobok obsahuje zdroj svetla triedy energetickej efektivity F          (EE) See toode sisaldab energiatõhususklassi F valgusallikat          (LV) Šis produkts satur enerģijas efektivitātes klases F gaismas avotu          (LT) Šis gaminys turi energijos efektyvumo klasės F šviesos šaltinį          (RO) Acest produs conține o sursă de lumină de clasă de eficiență energetică F          (SI) Ta izdelek vsebuje svetlobni vir energijskega razreda F          (HR) Ovaj proizvod sadrži izvor svjetlosti energetske učinkovitosti klase F          (HU) Ez a termék egy F energiahatékonysági osztályú fényforrást tartalmaz          (BG) Този продукт съдържа източник на светлина с клас на енергийна ефективност: F          (AL) Ky produkt përmban një burim drite të klasës së efikasitetit të energjisë F          (MK) Ovoj proizvod sadrži izvor na svetlina od klasa na energetska efikasnost F          (TR) Bu ürün, enerji verimliliği sınıfı F olan bir ışık kaynağı içerir          (UK) Цей продукт містить джерело світла класу енергоефективності F          (BA)(ME)(RS) Ovaj proizvod sadrži izvor svjetlosti energetske klase F</p>	<p>QR</p> 	<p>EAN</p> <p>4251911790481</p>
---	---	---------------------------------

	<p>(DE) Durch einen Fachmann austauschbare Lichtquelle (nur LED).          (EN) Replaceable (LED only) light source by a professional.          (FR) Source de lumière remplaçable (LED uniquement) par un professionnel.          (NL) Lichtbron (alleen led) te vervangen door een professional.          (PL) Wymienne (tylko LED) źródło światła wykonane przez profesjonalistę.          (NO) Utskiftbar (kun LED) lyskilde av en profesjonell.          (DK) Udskiftelig lyskilde (kun LED), udskiftes af en elektriker.          (SE) Ljuskälla (endast LED) utbytbar genom fackman.          (FI) Ammattilainen voi vaihtaa vaihdettavan (vain LED) valonlähteen.          (IT) Sorgente luminosa (solo LED) sostituibile da un professionista.          (ES) Fuente de luz (solo LED) sustituable por un profesional.          (CZ) Vyměnitelný (pouze LED) světelný zdroj odborníkem.          (PT) Luz LED (apenas LED) substituível por um profissional.          (GR) Η πηγή φωτός (μόνο LED) να αντικαθίσταται από επαγγελματία.          (SK) Zdroj svetla (iba LED) vymeniteľný prostredníctvom odborníka.          (EE) Spetsialisti poolt vahetatav valgusallikas (ainult LED).          (LV) Speciālista maināms gaismas avots (tikai LED).          (LT) Specialisto keičiamas šviesos šaltinis (tik LED).          (RO) Sursă de lumină schimbabilă de către un specialist (doar LED).          (SI) Svetlobni vir, ki ga lahko zamenja strokovnjak (samo LED).          (HR) Izvor svjetlosti koji može zamijeniti stručnjak (samo LED).          (HU) Szakember által cserélhető (csak LED) fényforrás.          (BG) Светлинен източник, който може да се смени от специалист (само LED).          (AL) Burim drite i zëvendësueshëm (LED vetëm) nga një profesionist.          (MK) Изворот на светлина (само LED) се заменува од професионалец.          (TR) Değiştirilebilir (yalnızca LED) ışık kaynağı bir profesyonel tarafından değiştirilir.          (UK) Замінний (тільки LED) джерело світла замінюється фахівцем.          (BA)(ME)(RS) Zamjenjiv (samo LED) izvor svjetlosti zamjenjuje profesionalac.</p>
--	--

	<p>(DE) Durch einen Fachmann austauschbares Betriebsgerät.          (EN) Replaceable control gear by a professional.          (FR) Contrôleur remplaçable par un professionnel.          (NL) Voorschakelapparatuur te vervangen door een professional.          (PL) Wymienny układ sterujący przez profesjonalistę.          (NO) Utskiftbar kontrollutstyr av en profesjonell.          (DK) Udskiftelig igangsætter, udskiftes af en elektriker.          (SE) Styrdon utbytbar genom fackman.          (FI) Ammattilainen voi vaihtaa vaihdettavat ohjauslaitteet.          (IT) Dispositivo di controllo sostituibile da un professionista.          (ES) Dispositivo de control sustituable por un profesional.          (CZ) Vyměnitelný předřadník odborníkem.          (PT) Dispositivo de controlo substituível por um profissional.          (GR) Ο εξοπλισμός ελέγχου να αντικαθίσταται από επαγγελματία.          (SK) Predradník vymeniteľný prostredníctvom odborníka.          (EE) Spetsialisti poolt vahetatav juhtseade.          (LV) Speciālista maināma vadības iekārta.          (LT) Specialisto keičiamas valdymo įrenginys.          (RO) Aparat de comandă schimbabil de către un specialist.          (SI) Nadomestna krmilna naprava, ki jo lahko zamenja strokovnjak.          (HR) Zamjenjivi upravljački sklop koji može zamijeniti stručnjak.          (HU) Szakember által cserélhető vezérlőszervezet.          (BG) Уред, който може да се смени от специалист.          (AL) Pajisje kontrolli e zëvendësueshme nga një profesionist.          (MK) Заменлива контролна опрема од страна на професионалец.          (TR) Profesyonel tarafından değiştirilebilir kontrol donanımı.          (UK) Замінний контрольний пристрій фахівцем.          (BA)(ME)(RS) Zamjenjiva kontrolna oprema od strane profesionalca.</p>
--	---