

## 9976124

2,3 + 19,5W LED / 3,4 + 21,5W Total  
incl. LED Board: L9001612 + L9001618  
230V ~ 50Hz

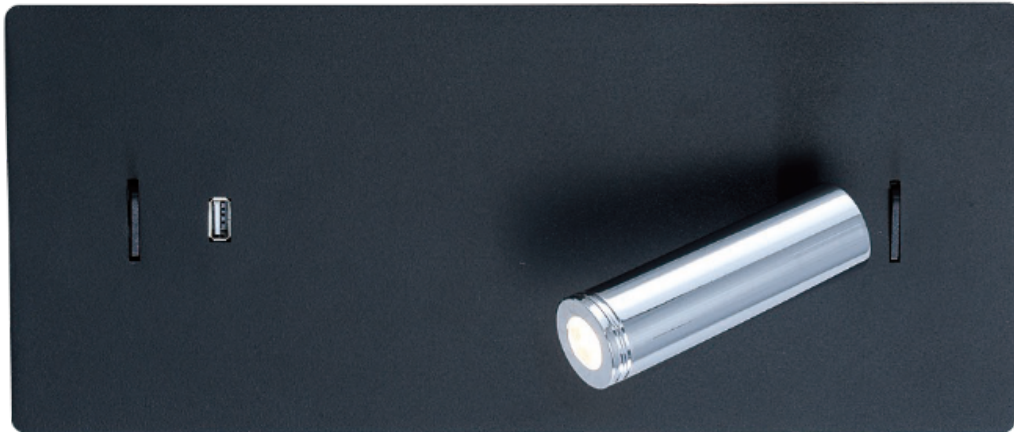

### (DE) Bestimmungsgemäße Verwendung

(EN) Intended use | (FR) Utilisation conforme | (NL) Beoogd gebruik | (PL) Stosowanie zgodnie z przeznaczeniem | (NO) Riktig bruk | (DK) Korrekt brug  
(SE) Avsedd användning | (FI) Määräystenmukainen käyttö | (IT) Impiego appropriato | (ES) Uso prescrito | (CZ) Použití v souladu s určením  
(PT) Utilização correta | (GR) Ενδεδειγμένη χρήση | (SK) Predpokladané použitie | (EE) Eeldatav kasutus | (LV) Paredzams lietojums  
(LT) Numatomas naudojimas | (RO) Utilizare intenționată | (SI) Predvidena uporaba | (HR) Namjenska upotreba | (HU) Tervezett felhasználás  
(BG) предназначена употреба | (AL) Përdorimi i parashikuar | (MK) Предвидена употреба | (TR) Amaçlı kullanım | (UK) Призначене використання  
(BA,ME,RS) Namjenska upotreba

(DE)	Ortsfeste Verwendung als Wandleuchte im Innenbereich	(GB)	For stationary use indoors as a wall light
(FR)	Installation fixe en tant qu'applique, à l'intérieur	(NL)	Vast gebruik als wandlamp binnenshuis
(PL)	Do montażu stacjonarnego jako lampa ścienna do wnętrza	(NO)	Til stasjonært bruk som vegglyppe innendørs
(DK)	Til stationær brug som væglampe indendørs	(SE)	Används som fast vägglyppa inomhus
(FI)	Kiinteä käyttö sisätilojen seinävalaisimena	(IT)	Impiego fisso come applique in ambienti interni
(ES)	Empleo fijo en tanto lámpara de pared en interiores	(CZ)	Stacionární použití jako nástěnné svítidlo v interiéru
(PT)	Aplicação fixa como luminária de parede em interiores	(GR)	Σταθερή χρήση ως φωτιστικό τοίχου σε εσωτερικό χώρο
(SK)	Na stacionárne použitie v interiéri ako nástenné svetlo	(BG)	За стационарна употреба на закрито като стенно осветление
(EE)	Stacionaarseks kasutamiseks siseruumides seinävalgustina	(LV)	Stacionāram lietojumam iekštelpās kā sienas gaismeklis
(LT)	Stacionariam naudojimui patalpose kaip sieninis šviestuvus	(RO)	Pentru utilizare staționară în interior ca lumină de perete
(SI)	Za stacionarno uporabo v zaprtih prostorih kot stenska svetilka	(HR)	Za stacionarnu upotrebu u zatvorenom prostoru kao zidno svjetlo
(HU)	Helyhez kötött használatra beltérben falilámpaként	(AL)	Për përdorim të palëvizshëm brenda si dritë murale
(MK)	За стационарна употреба внатре како светилка на ѕид	(TR)	Duvara monte edilmiş sabit kullanım için iç mekanda
(UK)	Для стаціонарного використання всередині як настінний світильник	(BA)	Za stacionarnu upotrebu unutar kao zidna svjetiljka
		(ME)	
		(RS)	

(DE) Lieferumfang (EN) Package contents   (FR) Contenu de la livraison   (NL) Bij de levering inbegrepen   (PL) Zakres dostawy   (NO) Levering   (DK) Leveringsomfang (SE) Leveransomfattning   (FI) Toimitussisältö   (IT) Fornitura   (ES) Volumen de suministro   (CZ) Rozsah dodávky   (PT) Material fornecido (GR) Παραδοτέος εξοπλισμός   (SK) Obsah balenia   (EE) Pakendi sisu   (LV) Pakas saturs   (LT) Pakuotės turinys (RO) Conținutul pachetului   (SI) Vsebina paketa   (HR) Sadržaj paketa   (HU) A csomag tartalma   (BG) обхват на доставката (AL) Përmbajtja e dorëzimit   (MK) Содржина на испорака   (TR) Teslimat içeriği   (UK) Зміст доставки   (BA,ME,RS) Sadržaj isporuke					
(DE)	1 Wandleuchte Montagematerial Montageanleitung	(GB)	1 Wall light Installation hardware Mounting instructions	(FR)	1 Applique Matériel de montage Instructions de montage
(NL)	1 Wandlamp Monteringsmateriale Montagehandleiding	(PL)	1 Lampa ścienna Elementy montażowe Instrukcja montażu	(NO)	1 Vegglampe Monteringsmateriale Brukerveiledning
(DK)	1 Væglampe Monteringsmateriale Brugervejledning	(SE)	1 Vägglampa Monteringsmaterial Monteringsanvisning	(FI)	1 Seinävalaisin Asennusmateriaali Asennusohjeet
(IT)	1 Applique Materiale di montaggio Istruzioni di montaggio	(ES)	1 Lámpara de pared Material de montaje Instrucciones de montaje	(CZ)	1 Nástěnné svítidlo Materiál pro montáž Návod k montáži
(PT)	1 Luminária de parede Material de montagem Instruções de montagem	(GR)	1 Φωτιστικό τοίχου Υλικό συναρμολόγησης Οδηγίες συναρμολόγησης	(SK)	1 nástenné svietidlo Inštalačný hardvér Inštalačná príručka
(BG)	1 стенна лампа материали за монтаж инструкции за монтаж	(EE)	1 seinävalgusti Paigaldustarvikud Paigaldusjuhend	(LV)	1 sienas gaisma Instalācijas aparātūra Uzstādīšanas instrukcija
(LT)	1 sieninis šviestuvas Montavimo aparatinė įranga Montavimo instrukcija	(RO)	1 lampă de perete Hardware de instalare Instrucțiuni de montare	(SI)	1 stenska svetilka Namestitvena strojna oprema Navodila za montažo
(HR)	1 Zidno svjetlo Instalacijski hardver Upute za montažu	(HU)	1 fali lámpa Telepítési hardver Szerezési útmutató	(AL)	1 dritë murale Materiali i montimit Udhëzuesi i montimit
(MK)	1 светилка за ѕид Монтажен материјал Упатство за монтажа	(TR)	1 duvar lambası Montaj malzemesi Montaj kılavuzu	(UK)	1 настінний світильник Монтажний матеріал Інструкція з монтажу
(BA)	1 zidna svjetiljka				
(ME)	Montažni materijal				
(RS)	Uputstvo za montažu				

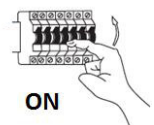
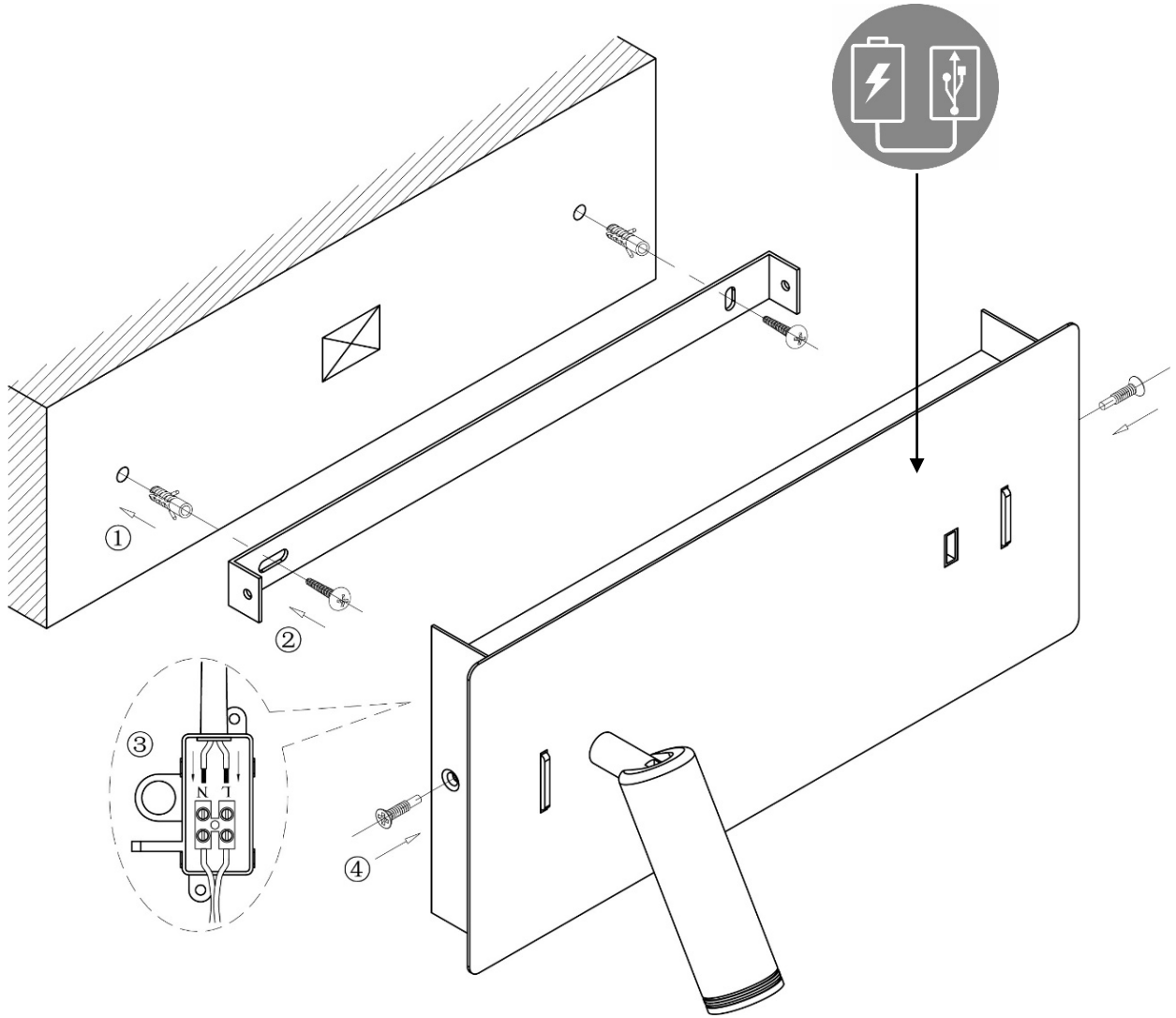
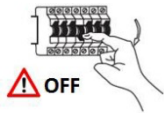

	(DE)	(EN)	(FR)	(NL)	(PL)	(NO)
<b>L</b>	Stromführender Leiter	Live conductor	Conducteur	Spanningvoerende draad	Przewód prądowy	Strømførende leder
<b>N</b>	Neutralleiter	Neutral conductor	Conducteur neutre	Nulleider	Przewód zerowy	Nøytralleider

	(DK)	(SE)	(FI)	(IT)	(ES)	(CZ)
<b>L</b>	Strømførende leder	Strömförande ledare	Virtajohdin	Conduttore sotto tensione	Conductor de corriente	Vodič pod napětím
<b>N</b>	Neutralleider	Neutralledare	Nollajohdin	Conduttore neutro	Conductor neutro	Neutrální vodič

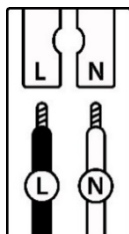

	(PT)	(GR)	(SK)	(EE)	(LV)	(LT)
<b>L</b>	Condutor vivo	Ρευματοφόρος αγωγός	Živý vodič	Faasijuht	Dzīvais vadītājs	Gyvas dirigentas
<b>N</b>	Condutor neutro	Ουδέτερος αγωγός	Neutrálny vodič	Neutraaljuht	Neitrālais vadītājs	Neutrinis dirigentas

	(RO)	(SI)	(HR)	(HU)	(BG)	(AL)
<b>L</b>	Conductor viu	Živi dirigent	Živi dirigent	Élő vezető	проводник под напряжение	Konduktor i gjallë
<b>N</b>	Conductor neutru	Neutralni dirigent	Neutralni dirigent	Semleges vezető	нулев проводник	Kondaktor neutral

	(MK)	(TR)	(UK)	(BA)(ME)(RS)
<b>L</b>	Жив кондуктор	Canlı yönetici	Живий диригент	Živi dirigent
<b>N</b>	Неутрален проводник	Nötr iletken	Нейтральний провідник	Neutralni provodnik

### (DE) Verwendete Symbole

(EN) Safety Precautions | (FR) Symboles utilisés | (NL) Gebruikte symbolen | (PL) Stosowane symbole | (NO) Brukte symboler | (DK) Brugte symboler  
 (SE) Använda symboler | (FI) Käytetyt symbolit | (IT) Simboli usati | (ES) Símbolos empleados | (CZ) Použité symboly | (PT) Símbolos utilizados  
 (GR) Χρησιμοποιούμενα σύμβολα | (SK) Bezpečnostné opatrenia | (EE) Ohutusabinõud | (LV) Drošības pasākumi  
 (LT) Saugos priemonės | (RO) Măsuri de precauție | (SI) Varnostni ukrepi | (HR) Mjere opreza | (HU) Használt szimbólumok | (BG) Мерки за безопасност  
 (AL) Simbolet e përdorura | (MK) Користени симболи | (TR) Kullanılan semboller | (UK) Використовувані символи | (BA,ME,RS) Korišteni simboli

IP 20

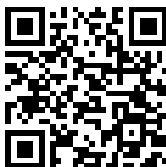

	QR	EAN
<p>(DE) Dieses Produkt enthält eine Lichtquelle der Energieeffizienzklasse F            (EN) This product contains a light source of energy efficiency class F            (FR) Ce produit comprend une source de lumière de classe d'efficacité énergétique F            (NL) Dit product bevat een lichtbron van energie-efficiëntieklasse F            (PL) Produkt ten zawiera źródło światła o klasie efektywności energetycznej F            (NO) Dette produktet inneholder en lyskilde i energieeffektivitetsklasse F            (DK) Dette produkt indeholder en lyskilde af energieeffektklasse F            (SE) Denna produkt innehåller en ljuskälla i energieffektivitetsklass F            (FI) Tämä tuote sisältää energiatehokkuusluokan F valonlähteen            (IT) Questo prodotto contiene una sorgente luminosa della classe di efficienza energetica F            (ES) Este producto contiene una fuente de luz de la clase de eficiencia energética F            (CZ) Tento výrobek obsahuje světelný zdroj třídy energetické účinnosti F            (PT) Este produto contém uma fonte de luz da classe de eficiência energética F            (GR) Αυτό το προϊόν περιέχει μια φωτεινή πηγή ενεργειακής απόδοσης κλάσης F            (SK) Tento výrobok obsahuje zdroj svetla triedy energetickej efektivity F            (EE) See toode sisaldab energiatõhususklassi F valgusallikat            (LV) Šis produkts satur enerģijas efektivitātes klases F gaismas avotu            (LT) Šis gaminy turi energijos efektyvumo klasės F šviesos šaltinį            (RO) Acest produs conține o sursă de lumină de clasă de eficiență energetică F            (SI) Ta izdelek vsebuje svetlobni vir energijskega razreda F            (HR) Ovaj proizvod sadrži izvor svjetlosti energetske učinkovitosti klase F            (HU) Ez a termék egy F energiahatékonysági osztályú fényforrást tartalmaz            (BG) Този продукт съдържа източник на светлина с клас на енергийна ефективност: F            (AL) Ky produkt përmban një burim drite të klasës së efikasitetit të energjisë F            (MK) Овој производ содржи извор на светлина од класа на енергетска ефикасност F            (TR) Bu ürün, enerji verimliliği sınıfı F olan bir ışık kaynağı içerir            (UK) Цей продукт містить джерело світла класу енергоефективності F            (BA)(ME)(RS) Ovaj proizvod sadrži izvor svjetlosti energetske klase F</p>		<p>4251911719253</p>

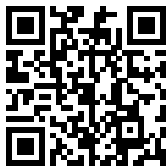
	QR	EAN
<p>(DE) Dieses Produkt enthält eine Lichtquelle der Energieeffizienzklasse E            (EN) This product contains a light source of energy efficiency class E            (FR) Ce produit comprend une source de lumière de classe d'efficacité énergétique E            (NL) Dit product bevat een lichtbron van energie-efficiëntieklasse E            (PL) Produkt ten zawiera źródło światła o klasie efektywności energetycznej E            (NO) Dette produktet inneholder en lyskilde i energieeffektivitetsklasse E            (DK) Dette produkt indeholder en lyskilde af energieeffektklasse E            (SE) Denna produkt innehåller en ljuskälla i energieffektivitetsklass E            (FI) Tämä tuote sisältää energiatehokkuusluokan E valonlähteen            (IT) Questo prodotto contiene una sorgente luminosa della classe di efficienza energetica E            (ES) Este producto contiene una fuente de luz de la clase de eficiencia energética E            (CZ) Tento výrobek obsahuje světelný zdroj třídy energetické účinnosti E            (PT) Este produto contém uma fonte de luz da classe de eficiência energética E            (GR) Αυτό το προϊόν περιέχει μια φωτεινή πηγή ενεργειακής απόδοσης κλάσης E            (SK) Tento výrobok obsahuje zdroj svetla triedy energetickej efektivity E            (EE) See toode sisaldab energiatõhususklassi E valgusallikat            (LV) Šis produkts satur enerģijas efektivitātes klases E gaismas avotu            (LT) Šis gaminy turi energijos efektyvumo klasės E šviesos šaltinį            (RO) Acest produs conține o sursă de lumină de clasă de eficiență energetică E            (SI) Ta izdelek vsebuje svetlobni vir energijskega razreda E            (HR) Ovaj proizvod sadrži izvor svjetlosti energetske učinkovitosti klase E            (HU) Ez a termék egy E energiahatékonysági osztályú fényforrást tartalmaz            (BG) Този продукт съдържа източник на светлина с клас на енергийна ефективност: E            (AL) Ky produkt përmban një burim drite të klasës së efikasitetit të energjisë E            (MK) Овој производ содржи извор на светлина од класа на енергетска ефикасност E            (TR) Bu ürün, enerji verimliliği sınıfı E olan bir ışık kaynağı içerir            (UK) Цей продукт містить джерело світла класу енергоефективності E            (BA)(ME)(RS) Ovaj proizvod sadrži izvor svjetlosti energetske klase E</p>		<p>4251911719314</p>

	<p>(DE) Durch einen Fachmann austauschbare Lichtquelle (nur LED).          (EN) Replaceable (LED only) light source by a professional.          (FR) Source de lumière remplaçable (LED uniquement) par un professionnel.          (NL) Lichtbron (alleen led) te vervangen door een professional.          (PL) Wymienne (tylko LED) źródło światła wykonane przez profesjonalistę.          (NO) Utskiftbar (kun LED) lyskilde av en profesjonell.          (DK) Udskiftelig lyskilde (kun LED), udskiftes af en elektriker.          (SE) Ljuskälla (endast LED) utbytbar genom fackman.          (FI) Ammattilainen voi vaihtaa vaihdettavan (vain LED) valonlähteen.          (IT) Sorgente luminosa (solo LED) sostituibile da un professionista.          (ES) Fuente de luz (solo LED) sustituable por un profesional.          (CZ) Vyměnitelný (pouze LED) světelný zdroj odborníkem.          (PT) Luz LED (apenas LED) substituível por um profissional.          (GR) Η πηγή φωτός (μόνο LED) να αντικαθίσταται από επαγγελματία.          (SK) Zdroj svetla (iba LED) vymeniteľný prostredníctvom odborníka.          (EE) Spetsialisti poolt vahetatav valgusallikas (ainult LED).          (LV) Speciālista maināms gaismas avots (tikai LED).          (LT) Specialisto keičiamas šviesos šaltinis (tik LED).          (RO) Sursă de lumină schimbabilă de către un specialist (doar LED).          (SI) Svetlobni vir, ki ga lahko zamenja strokovnjak (samo LED).          (HR) Izvor svjetlosti koji može zamijeniti stručnjak (samo LED).          (HU) Szakember által cserélhető (csak LED) fényforrás.          (BG) Светлинен източник, който може да се смени от специалист (само LED).          (AL) Burim drite i zëvendësueshëm (LED vetëm) nga një profesionist.          (MK) Изворот на светлина (само LED) се заменува од професионалец.          (TR) Değiştirilebilir (yalnızca LED) ışık kaynağı bir profesyonel tarafından değiştirilir.          (UK) Замінний (тільки LED) джерело світла замінюється фахівцем.          (BA)(ME)(RS) Zamjenjiv (samo LED) izvor svjetlosti zamjenjuje profesionalac.</p>
--	--

	<p>(DE) Durch einen Fachmann austauschbares Betriebsgerät.          (EN) Replaceable control gear by a professional.          (FR) Contrôleur remplaçable par un professionnel.          (NL) Voorschakelapparatuur te vervangen door een professional.          (PL) Wymienny układ sterujący przez profesjonalistę.          (NO) Utskiftbar kontrollutstyr av en profesjonell.          (DK) Udskiftelig igangsætter, udskiftes af en elektriker.          (SE) Styrdon utbytbar genom fackman.          (FI) Ammattilainen voi vaihtaa vaihdettavat ohjauslaitteet.          (IT) Dispositivo di controllo sostituibile da un professionista.          (ES) Dispositivo de control sustituable por un profesional.          (CZ) Vyměnitelný předřadník odborníkem.          (PT) Dispositivo de controlo substituível por um profissional.          (GR) Ο εξοπλισμός ελέγχου να αντικαθίσταται από επαγγελματία.          (SK) Predradník vymeniteľný prostredníctvom odborníka.          (EE) Spetsialisti poolt vahetatav juhtseade.          (LV) Speciālista maināma vadības iekārta.          (LT) Specialisto keičiamas valdymo įrenginys.          (RO) Aparat de comandă schimbabil de către un specialist.          (SI) Nadomestna krmilna naprava, ki jo lahko zamenja strokovnjak.          (HR) Zamjenjivi upravljački sklop koji može zamijeniti stručnjak.          (HU) Szakember által cserélhető vezérlőszerkezet.          (BG) Уред, който може да се смени от специалист.          (AL) Pajisje kontrolli e zëvendësueshme nga një profesionist.          (MK) Заменлива контролна опрема од страна на професионалец.          (TR) Profesyonel tarafından değiştirilebilir kontrol donanımı.          (UK) Замінний контрольний пристрій фахівцем.          (BA)(ME)(RS) Zamjenjiva kontrolna oprema od strane profesionalca.</p>
--	---