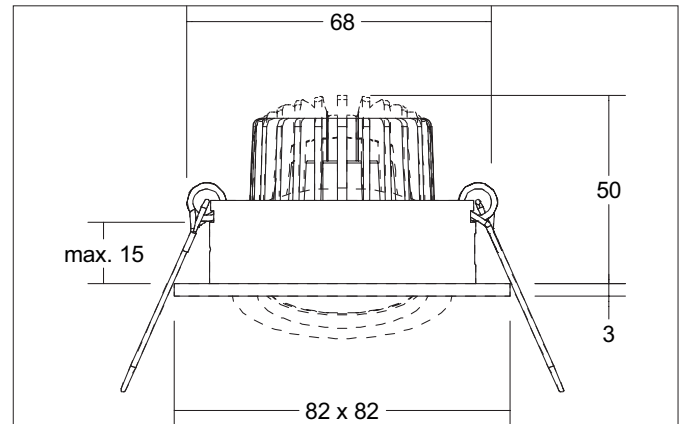

**TIRREL-S LED recessed spot set, trailing-edge phase dimmable
(round converter)**

Article no. 40144643

Light.
For Generations.**Tender**

LED recessed spot set, trailing-edge phase dimmable (round converter), Square. Toolless ceiling installation by installation springs. Ceiling cut-out Ø 68 mm, Installation depth 50 mm, Length 82 mm, Width 82 mm, Weight 0,151 kg, Reflector silver with rotationssymmetrical, deep, wide distributed light intensity. optimal light distribution due to a glass transparent cover. Luminous flux 680 lm, Power 1 x 6 W, Light colour warm white, Correlated color temperature (CCT) 3.000 K, Colour rendering index CRI > 80, Rated life time L70/B50 at 25 °C: 30.000 h, Housing material: Steel / Aluminium / Glass, Colour: White, Permissible ambient temperature (ta): -20 °C - +25 °C, Protection class (EN 61140): II, Degree of protection (DIN EN 60529): IP20, .With electronic driver, Trailing-edge phase dimmable.

Product Benefits

- LED recessed spot in square design made of solid aluminum.
with LED module 6 W (3,000 K) and dimmable round converter trailing-edge phase.
- Ceiling cutout 68 mm, diameter 82 mm, installation depth 50 mm, IP20.
- Pivoting range 25°.
- Large color variation. Without visible snap ring.
- Classic, formally restrained design.
- In the same optics also in GX5,3 or GU10 version and as dimmable DALI set and as a loudspeaker.
- In addition, in the same surface structure and in the same color also available in round design.

**TIRREL-S LED recessed spot set, trailing-edge phase dimmable
(round converter)**

Article no. 40144643

Light.
For Generations.

Article data	
Article no.	40144643
GTIN	4251433950660
Series name	TIRREL-S
Short description	LED recessed spot set, trailing-edge phase dimmable (round converter)
Material	Steel / Aluminium / Glass
Colour	White
Type of surface	Matt
Shape	Square
Built-in diameter	68 mm
Installation depth	50 mm
Length	82 mm
Width	82 mm
Height	3 mm
Weight	0.151 kg

Lighting technology	
Colour temperature	3.000 K
Light colour	White
Light output	Direct
Luminous flux	680 lm
System efficiency	113 lm/W
Colour rendering	CRI > 80
Reflector	High-gloss
Reflektorfarbe	silver
Beam angle	38°
Light sharing	Symmetric

Operating technology of the luminaire	
Lamp holder	Plug&Play
Power	6 W
Voltage type	DC
Current	350 mA
Lamp	LED
Protection class	III
Degree of protection	IP20
Bulb change possible	The light source of this luminaire may only be replaced by the manufacturer or a service technician commissioned by him or a similarly qualified person.

Mounting technology	
Mounting method	Recessed mounting
Place of installation	Ceiling-mounted
Adjustability	Pivoted
Swivel angle	20°
Max. ceiling thickness	15 mm
Further references	No cover with thermal insulation material
Material cover	Glass transparent
Circlip	Without circlip
Suitable for through-wiring	Yes, with optional accessories

TIRREL-S LED recessed spot set, trailing-edge phase dimmable**(round converter)**

Article no. 40144643

Light.

For Generations.

Packing data	
Gross weight	0.191 kg
Length of packaging	95 mm
Packaging width	75 mm
Packaging height	95 mm
Disposal at end of life	<p>This product must not be disposed of with household waste. You are obliged, to dispose of such electrical waste separately.</p> <p>By disposing of electrical waste and other old or defective electronics separately, you support recycling or other forms of re-use. In that way you help to take care and to avoid that harmful substances get into the environment.</p>