

10038153

1x E27 LED max. 15W

220-240V ~ 50/60Hz

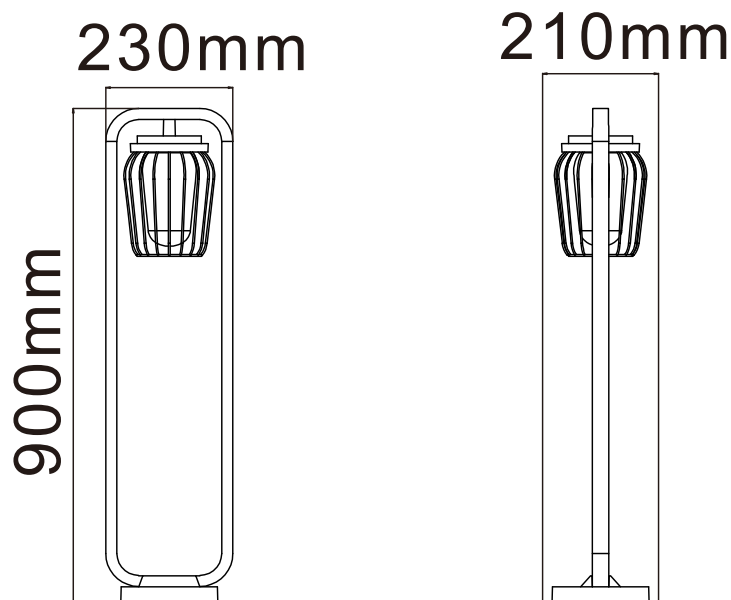

(DE) Bestimmungsgemäße Verwendung

(EN) Intended use | (FR) Utilisation conforme | (NL) Beoogd gebruik | (PL) Stosowanie zgodnie z przeznaczeniem | (NO) Riktig bruk | (DK) Korrekt brug
 (SE) Avsedd användning | (FI) Määräystenmukainen käyttö | (IT) Impiego appropriato | (ES) Uso prescrito | (CZ) Použití v souladu s určením
 (PT) Utilização correta | (GR) Ενδεικτική χρήση | (SK) Predpokladané použitie | (EE) Eeldatav kasutus | (LV) Paredzams lietojums
 (LT) Numatomas naudojimas | (RO) Utilizare intenționată | (SI) Predvidena uporaba | (HR) Namjenska upotreba | (HU) Tervezett felhasználás
 (BG) предназначена употреба | (AL) Përdorimi i parashikuar | (MK) Предвидена употреба | (TR) Amaçlı kullanım | (UK) Призначене використання
 (BA,ME,RS) Namjenska upotreba

(DE)	Ortsfeste Verwendung an Wegen/in Beeten im Außenbereich	(GB)	For stationary use outdoors on paths or in flower beds
(FR)	Pose fixe le long des allées/des parterres de plantes, à l'extérieur	(NL)	Vast gebruik langs paden en bloembedden buitenshuis
(PL)	Do montażu stacjonarnego na zewnątrz przy drogach/ grządkach	(NO)	Til stasjonært bruk på veier og i bed utendørs
(DK)	Til stationær brug på veje og i bed udendørs	(SE)	Fast användning vid stigar/rabatter utomhus
(FI)	Kiinteä käyttö ulkotilojen kulkureiteillä/kukkapenkeissä	(IT)	Impiego fisso su sentieri/aiuole in ambienti esterni
(ES)	Empleo fijo en caminos / jardineras en el exterior	(CZ)	Stacionární použití jako cestiček u záhonů v exteriéru
(PT)	Aplicação fixa para caminhos/ canteiros em exteriores	(GR)	Σταθερή χρήση σε διαδρόμους/παρτέρια σε εξωτερικό χώρο
(SK)	Na stacionárne použitie vo vonkajšom prostredí na chodníkoch alebo v záhonoch	(BG)	За стационарна употреба на открито по пътеки или в цветни лехи
(EE)	Statsionaarseks kasutamiseks õues radadel või lillepeenardel	(LV)	Stacionārai izmantošanai ārpus telpām uz celiņiem vai puķu dobēs
(LT)	Stacionariam naudojimui lauke ant takų arba gėlynuose	(RO)	Pentru utilizare staționară în exterior pe alei sau în straturile de flori
(SI)	Za stacionarno uporabo na prostem na poteh ali cvetličnih gredah	(HR)	Za stacionarnu upotrebu vani na stazama ili u cvjetnim gredicama
(HU)	Helyhez kötött használatra kültéren utakon vagy virágágyásokban	(AL)	Për përdorim të palëvizshëm jashtë në rrugë ose në kopshte lulesh
(MK)	За стационарна употреба надвор на патеки или во цветни градини	(TR)	Yollarda veya çiçek yataklarında durağan kullanım için
(UK)	Для стаціонарного використання на вулицях або в квіткових клумбах	(BA)	Za stacionarnu upotrebu na stazama ili u cvjetnim gredicama
		(ME)	
		(RS)	

(DE) Lieferumfang		
(EN) Package contents (FR) Contenu de la livraison (NL) Bij de levering inbegrepen (PL) Zakres dostawy (NO) Levering (DK) Leveringsomfang (SE) Leveransomfattning (FI) Toimitussisältö (IT) Fornitura (ES) Volumen de suministro (CZ) Rozsah dodávky (PT) Material fornecido (GR) Παραδοτέος εξοπλισμός (SK) Obsah balenia (EE) Pakendi sisu (LV) Pakas saturs (LT) Pakuotės turinys (RO) Conținutul pachetului (SI) Vsebina paketa (HR) Sadržaj paketa (HU) A csomag tartalma (BG) обхват на доставката (AL) Përmbajtja e dorëzimit (MK) Содржина на испорака (TR) Teslimat içeriği (UK) Зміст доставки (BA,ME,RS) Sadržaj isporuke		
(DE) 1 Wegeleuchte Montagematerial Montageanleitung	(GB) 1 Path light Installation hardware Mounting instructions	(FR) 1 Borne lumineuse Matériel de montage Instructions de montage
(NL) 1 Padverlichting Monteringsmateriale Montagehandleiding	(PL) 1 Stupek oświetleniowy Elementy montażowe Instrukcja montażu	(NO) 1 Gatelampe Monteringsmateriale Brukerveiledning
(DK) 1 Gadelys Monteringsmateriale Brugervejledning	(SE) 1 Väglykta Monteringsmaterial Monteringsanvisning	(FI) 1 Pylväsvalaisin Asennusmateriaali Asennusohjeet
(IT) 1 Lampioncino Materiale di montaggio Istruzioni di montaggio	(ES) 1 Lámpara para caminos Material de montaje Instrucciones de montaje	(CZ) 1 Osvětlení cestiček Materiál pro montáž Návod k montáži
(PT) 1 Luminária técnica Material de montagem Instruções de montagem	(GR) 1 Φωτιστικό διαδρόμων Υλικά συναρμολόγησης Οδηγίες συναρμολόγησης	(SK) 1 cestné svetlo Inštalačný hardvér Inštalačná príručka
(BG) 1 светлина за пътека материали за монтаж инструкции за монтаж	(EE) 1 teevalgusti Paigaldustarvikud Paigaldusjuhend	(LV) 1 ceļa gaisma Instalācijas aparatūra Uzstādīšanas instrukcija
(LT) 1 kelio žibintas Montavimo aparatinė įranga Montavimo instrukcija	(RO) 1 lampă de cărare Hardware de instalare Instrucțiuni de montare	(SI) 1 svetilka za pot Namestitvena strojna oprema Navodila za montažo
(HR) 1 svjetlo staze Instalacijski hardver Upute za montažu	(HU) 1 ösvény világítás Telepítési hardver Szerelési útmutató	(AL) 1 dritë për rrugë Materiali i montimit Udhëzuesi i montimit
(MK) 1 светло за патека Монтажен материјал Упатство за монтажа	(TR) 1 yol lambası Montaj malzemesi Montaj kılavuzu	(UK) 1 світло для стежки Монтажний матеріал Інструкція з монтажу
(BA) 1 svjetlo za stazu (ME) Montažni materijal (RS) Uputstvo za montažu		



OUTDOOR

You will need

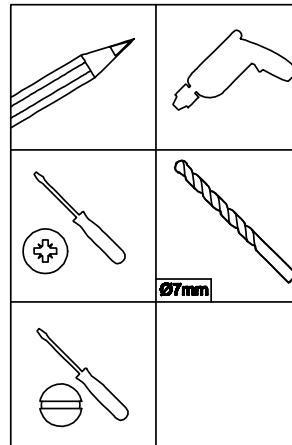

01

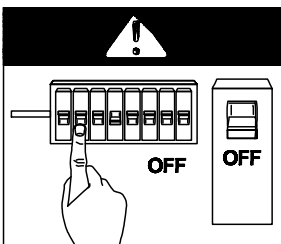

02

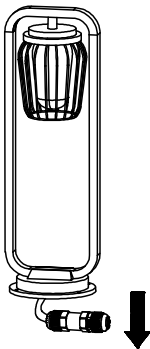

03

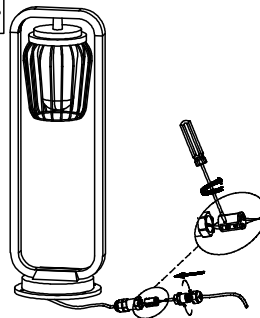

04

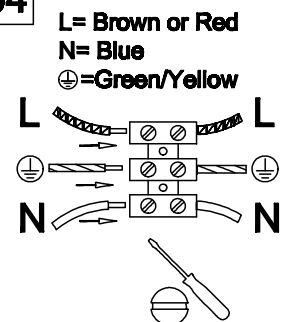

05

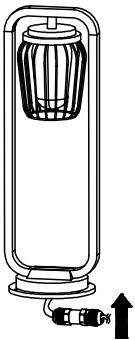

06

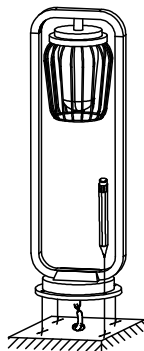

07

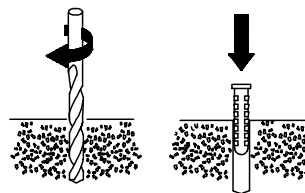

08

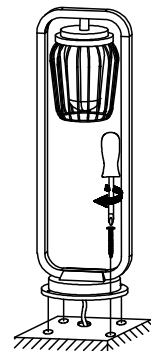

09

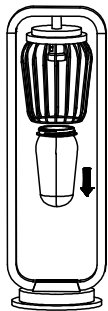

10

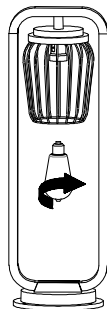

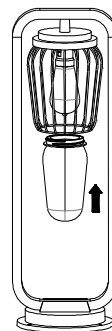

11



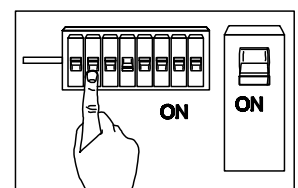

12

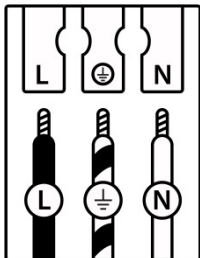

	(DE)	(EN)	(FR)	(NL)	(PL)	(NO)
L	Stromführender Leiter	Live conductor	Conducteur	Spanningvoerende draad	Przewód prądowy	Strømførende leder
	Schutzleiter	Earth conductor	Conducteur de protection (terre)	Aardkabel	Przewód uziemiający	Jordledningen
N	Neutralleiter	Neutral conductor	Conducteur neutre	Nulleider	Przewód zerowy	Nøytralleider

	(DK)	(SE)	(FI)	(IT)	(ES)	(CZ)
L	Strømførende leder	Strömförande ledare	Virtajohdin	Conduttore sotto tensione	Conductor de corriente	Vodič pod napětím
	Jordledningen	Skyddsledare	Suojajohdin	Conduttore di terra	Conductor de protección	Ochranný vodič
N	Neutralleider	Neutralledare	Nollajohdin	Conduttore neutro	Conductor neutro	Neutrální vodič



	(PT)	(GR)	(SK)	(EE)	(LV)	(LT)
L	Condutor vivo	Ρευματοφόρος αγωγός	Živý vodič	Faasisjuht	Dzīvais vadītājs	Gyvas dirigentas
	Condutor de terra	Αγωγός γείωσης	Zemný vodič	Maandusjuht	Zemes vadītājs	Žemės dirigentas
N	Condutor neutro	Ουδέτερος αγωγός	Neutrálny vodič	Neutraaljuht	Neitrālais vadītājs	Neutrinis dirigentas

	(RO)	(SI)	(HR)	(HU)	(BG)	(AL)
L	Conductor viu	Živi dirigent	Živi dirigent	Élő vezető	проводник под напряжение	Konduktor i gjallë
	Conductor de împământare	Zemeljski dirigent	Uzemljeni dirigent	Földvezető	защитен проводник	Dirigjent i tokës
N	Conductor neutru	Neutralni dirigent	Neutralni dirigent	Semleges vezető	нулев проводник	Konduktor neutral

	(MK)	(TR)	(UK)	(BA)(ME)(RS)
L	Жив кондуктор	Canlı yönetici	Живий диригент	Živi dirigent
	Земјен проводник	Toprak iletkeni	Земельний провідник	Zemaljski provodnik
N	Неутрален проводник	Nötr iletken	Нейтральний провідник	Neutralni provodnik

(DE) Verwendete Symbole

(EN) Safety Precautions | (FR) Symboles utilisés | (NL) Gebruikte symbolen | (PL) Stosowane symbole | (NO) Brukte symboler | (DK) Brugte symboler | (SE) Använda symboler | (FI) Käytetyt symbolit | (IT) Simboli usati | (ES) Símbolos empleados | (CZ) Použité symboly | (PT) Símbolos utilizados | (GR) Χρησιμοποιούμενα σύμβολα | (SK) Bezpečnostné opatrenia | (EE) Ohutusabinõud | (LV) Drošības pasākumi | (LT) Saugos priemonės | (RO) Măsuri de precauție | (SI) Varnostni ukrepi | (HR) Mjere opreza | (HU) Használt szimbólumok | (BG) Мерки за безопасност | (AL) Simbolet e përdorura | (MK) Користени симболи | (TR) Kullanılan semboller | (UK) Використовувані символи | (BA,ME,RS) Korišteni simboli

IP 54

