

HOPE

design Francisco Gomez Paz / Paolo Rizzatto

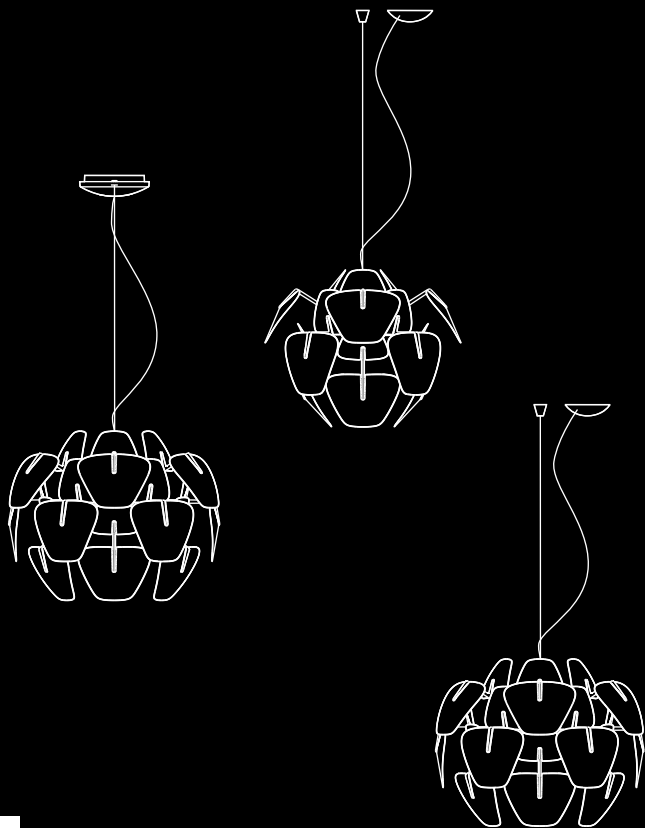

**LUCE
PLAN**

D66



D66/12

D66/18

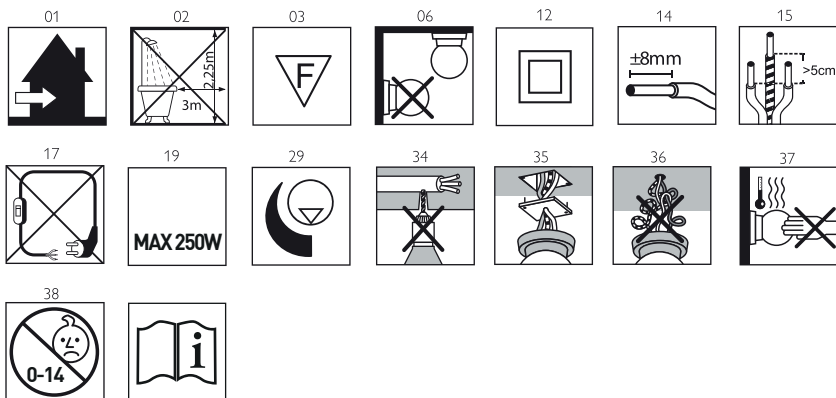

D66/18 EL

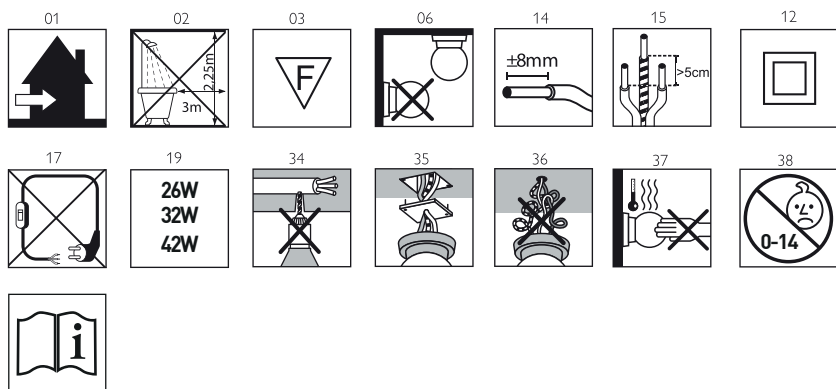

D66/18EL D

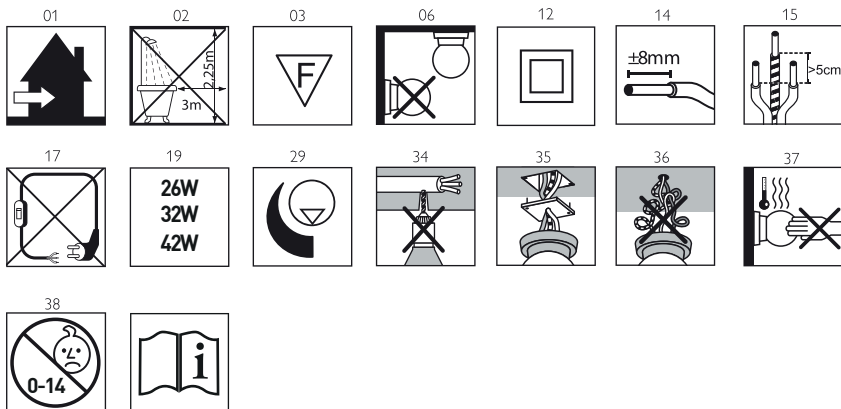

D66/12



a



b

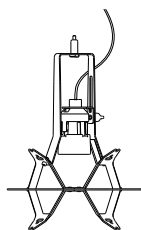
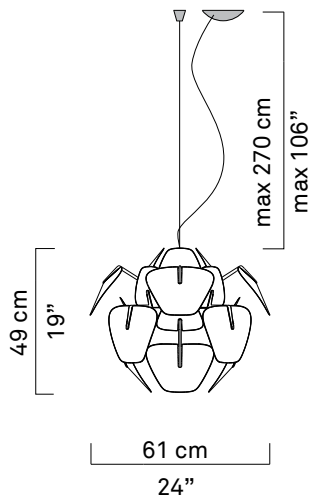

x 1



x 1



x 1



x 1



x 1



x 2



x 12



x 12



x 12

kg 1,5 kg **lb** 3.3 lb

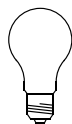

max 250W
E27



105W
HSGSA
E27
Energy saver



23W
FB
E27
fluorescent



max 20W
SBLEDLAMP
E27

D66/18



a



b

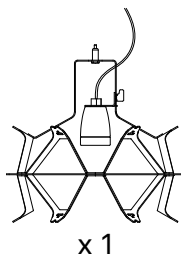
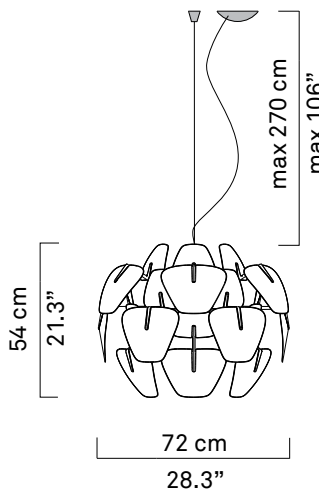

x 1



x 1



x 1

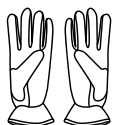

x 1



x 2



x 18



x 18



x 18

kg 2,2 kg

lb 14.9 lb



max 250W
E27

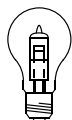

105W
HSGSA
E27
Energy saver

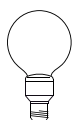

23W
FB
E27
fluorescent

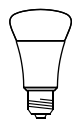

max 20W
SBLEDLAMP
E27

1

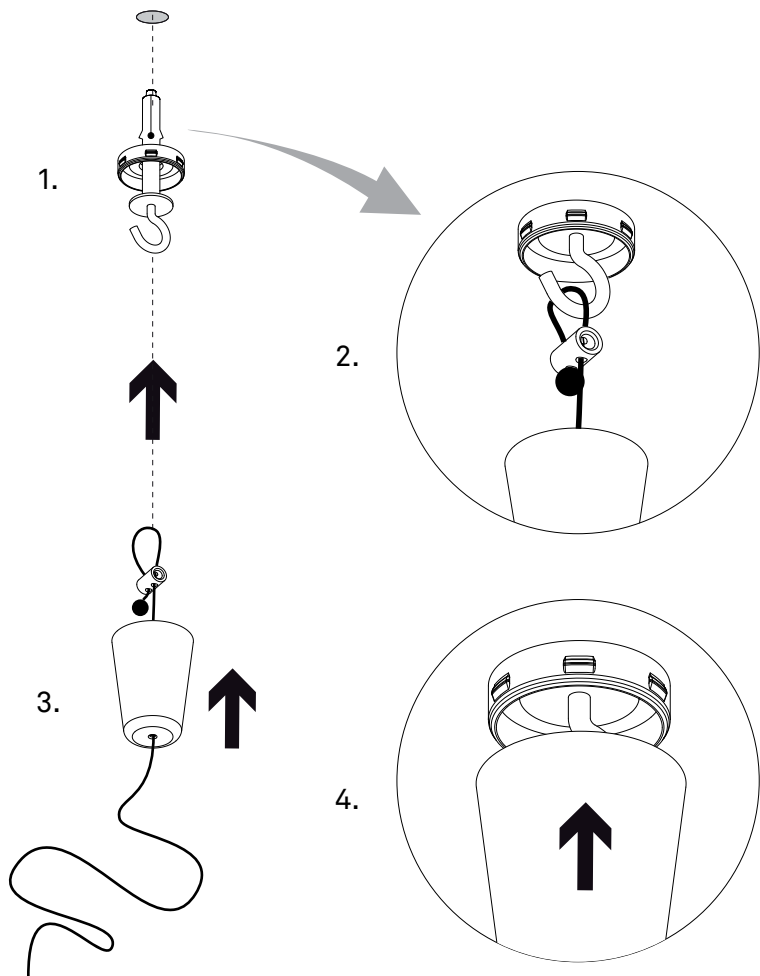
 D66/12 - D66/18

1.2

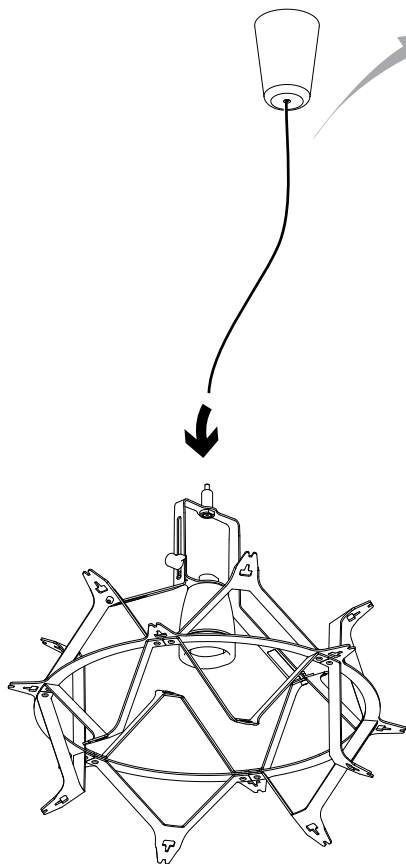

1.

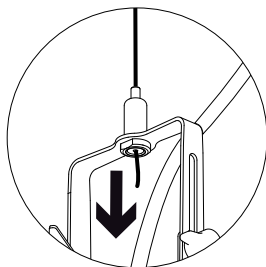

2.

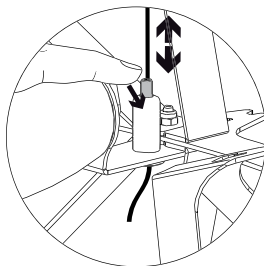

3.

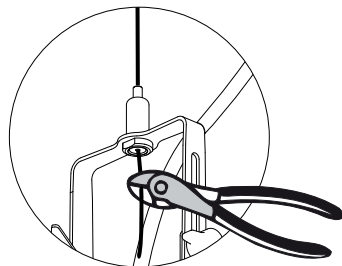

2

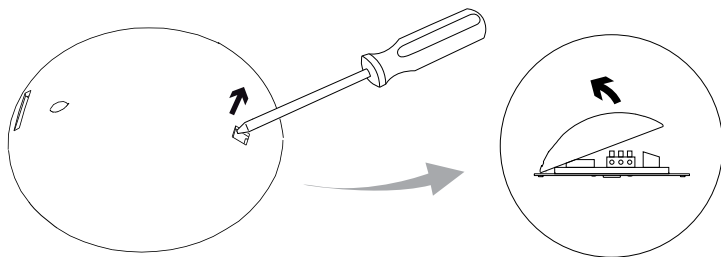
 D66/12 - D66/18

2.1

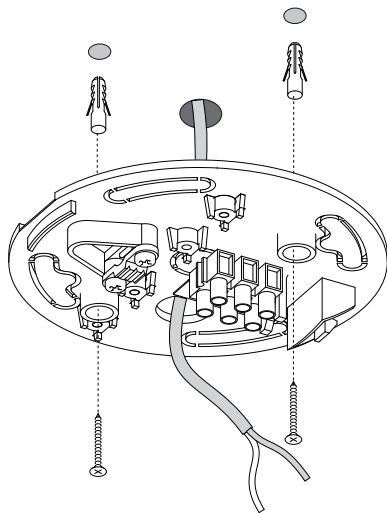
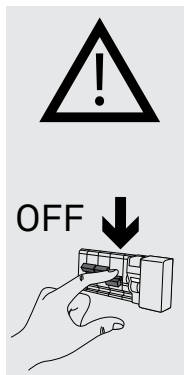

2.2

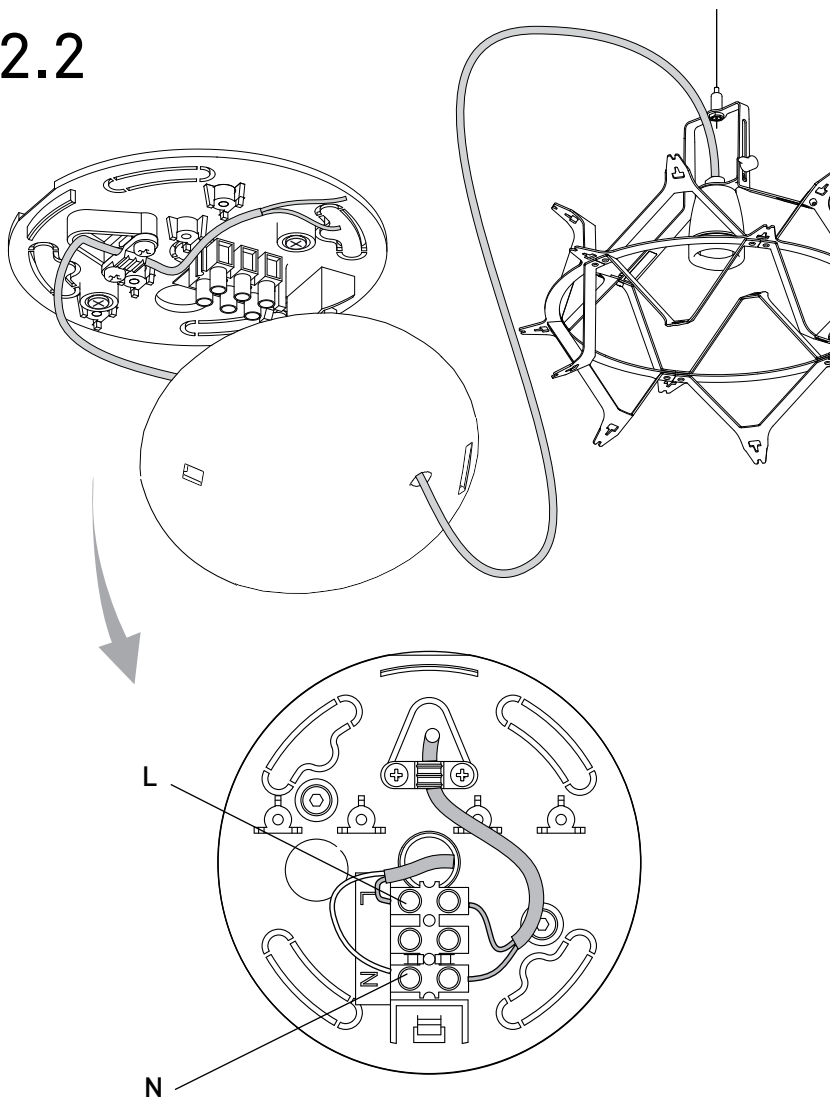

2.3

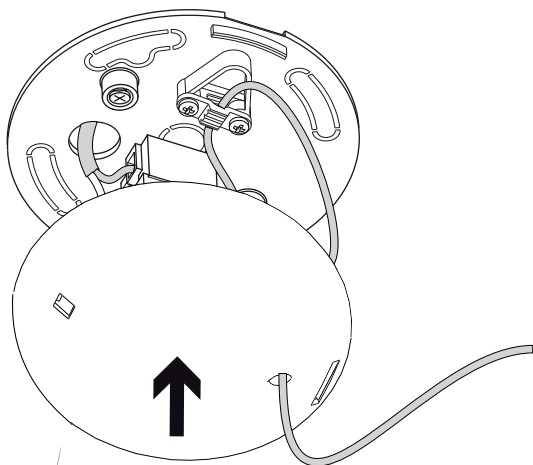

1.

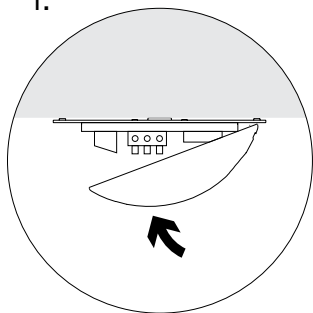

2.

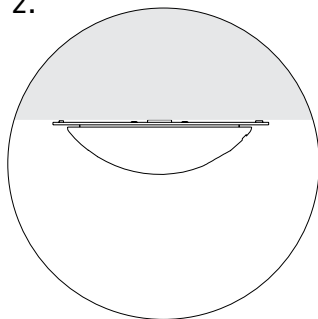

D66/18 EL - D66/18 EL D

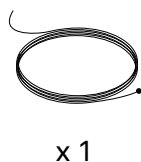
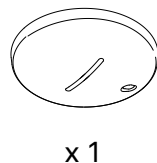
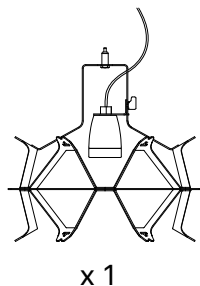
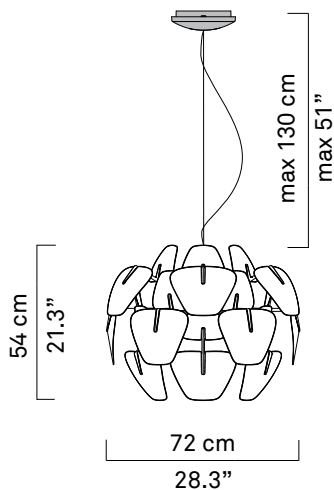

x 1



x 2



x 18



x 18



x 18

kg 2,6 kg

lb 5.7 lb



26 W - 32W - 42 W
FSM
GX24 q-3/4

1

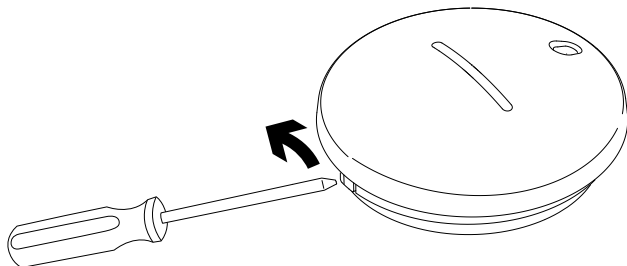
 D66/18 EL - D66/18 EL D

1.1

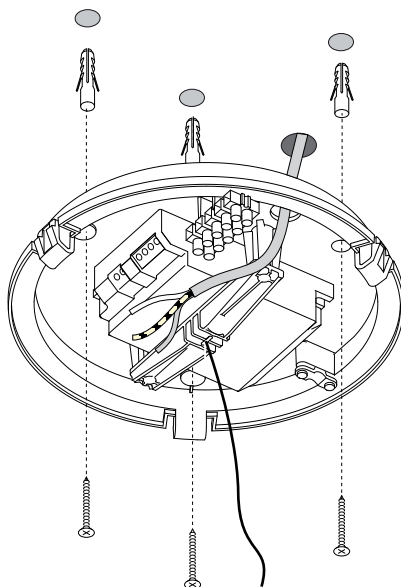

1.2

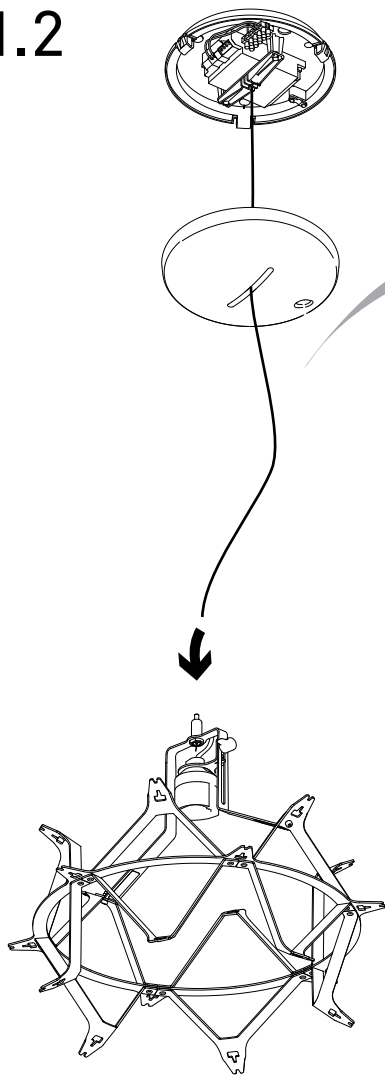

1.

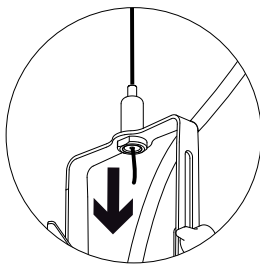

2.

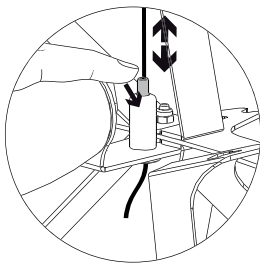

3.

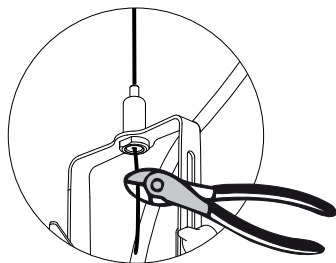

1.3

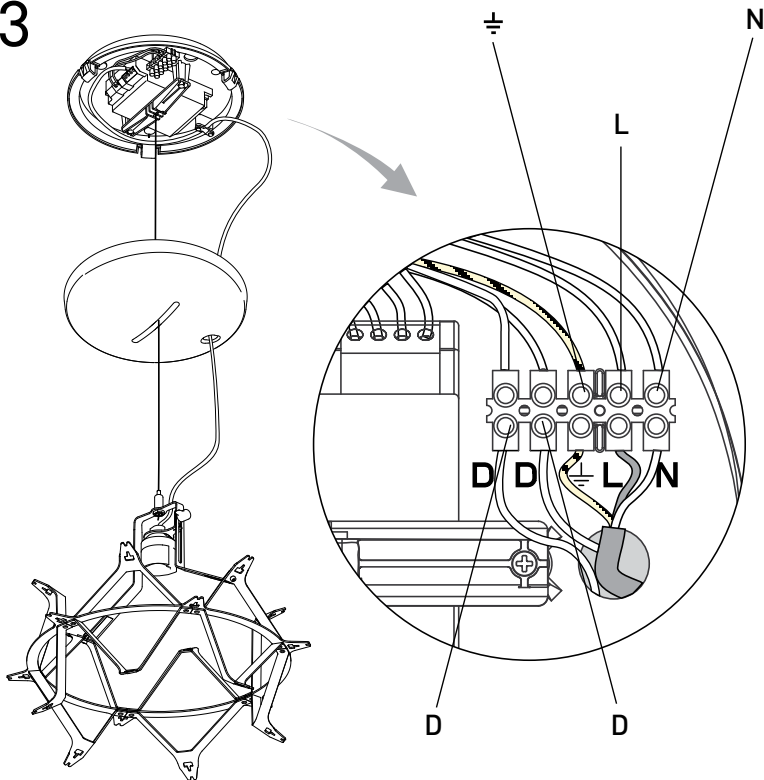

1.4

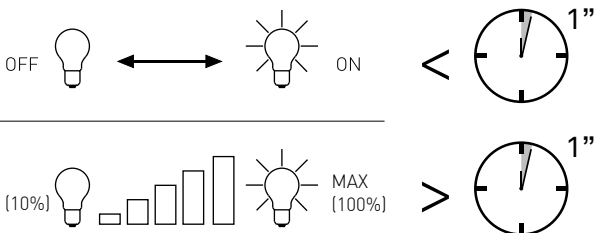
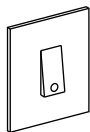
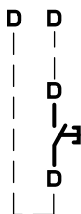
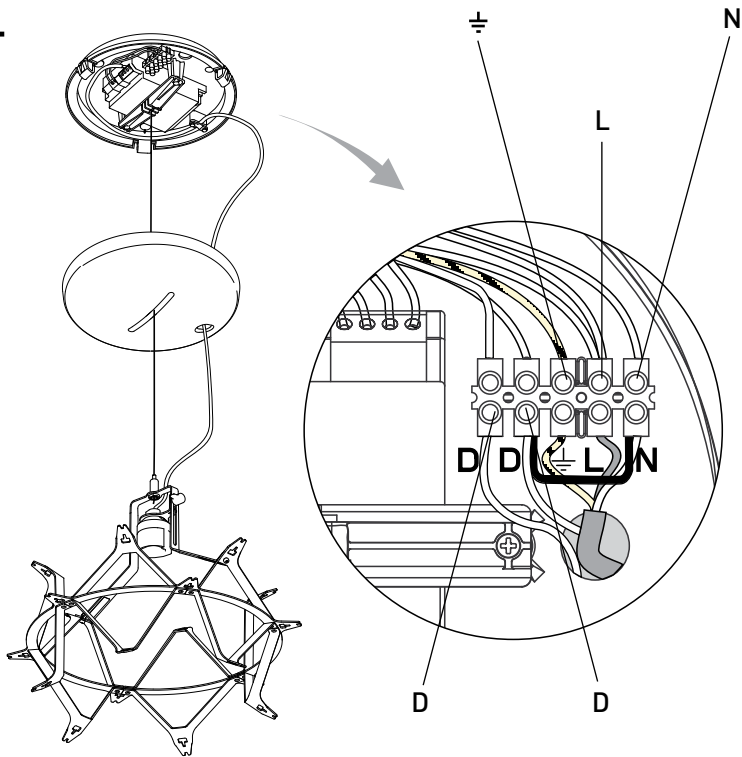

1.5

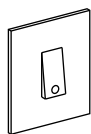
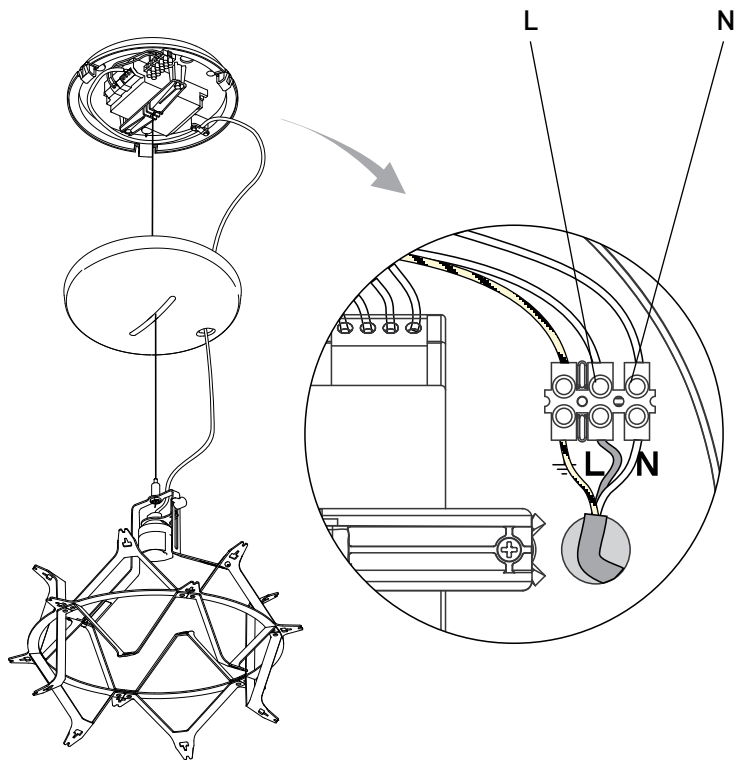

OFF



ON

2

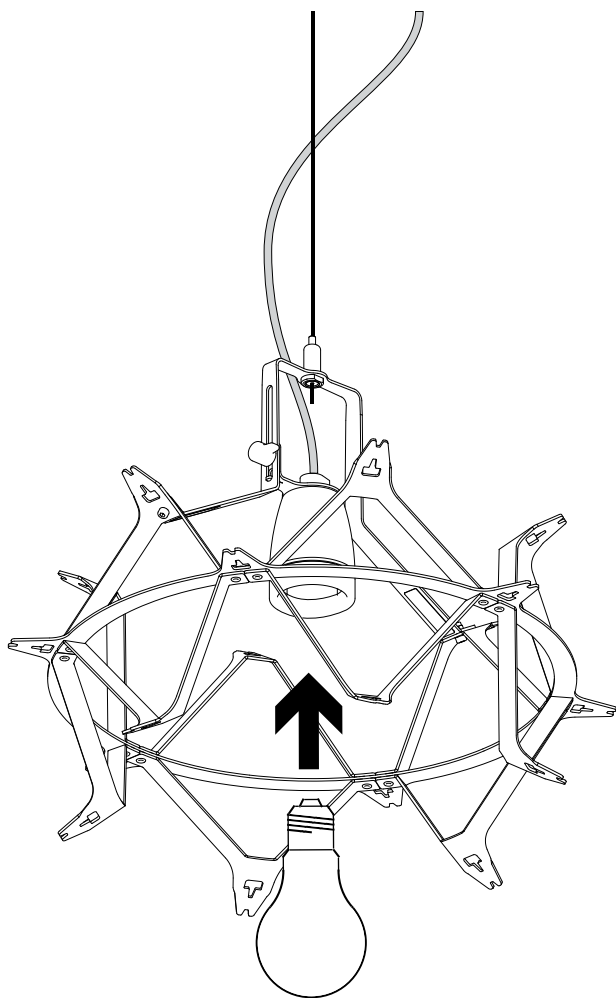

2.1

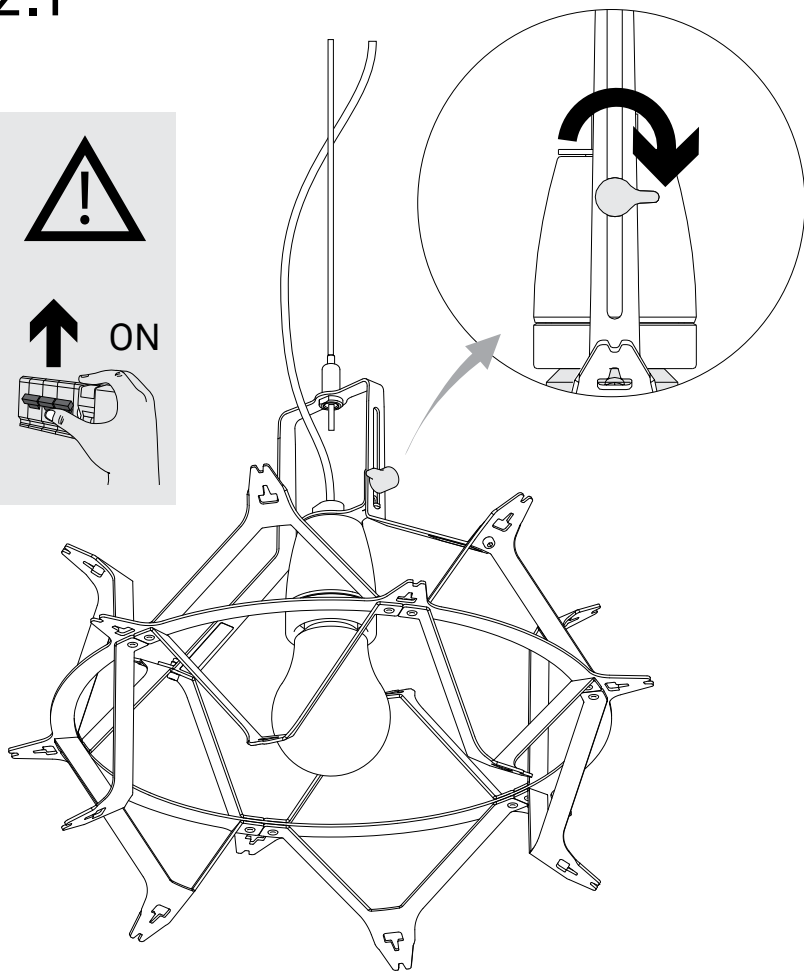
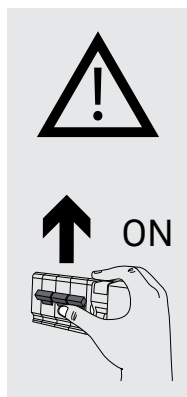

3

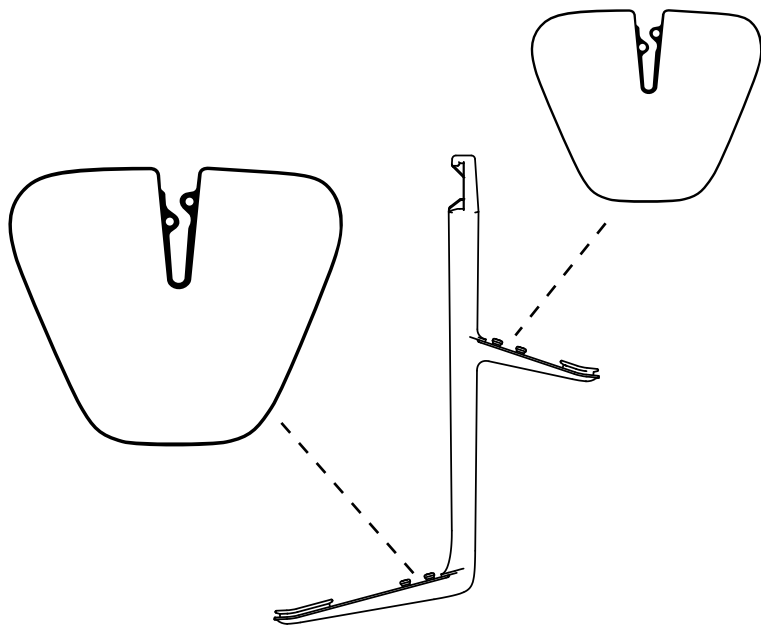

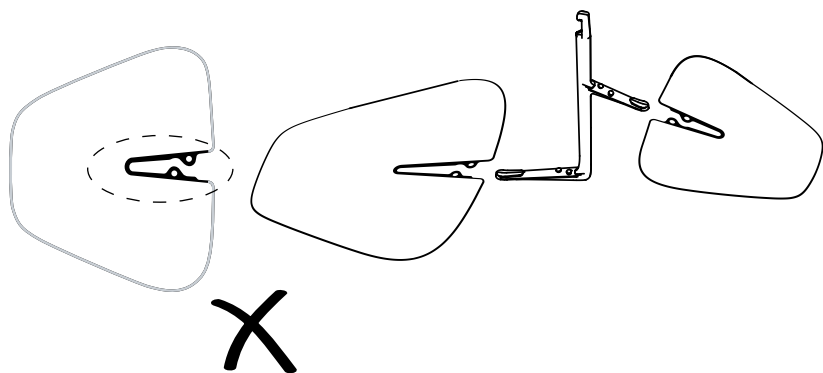
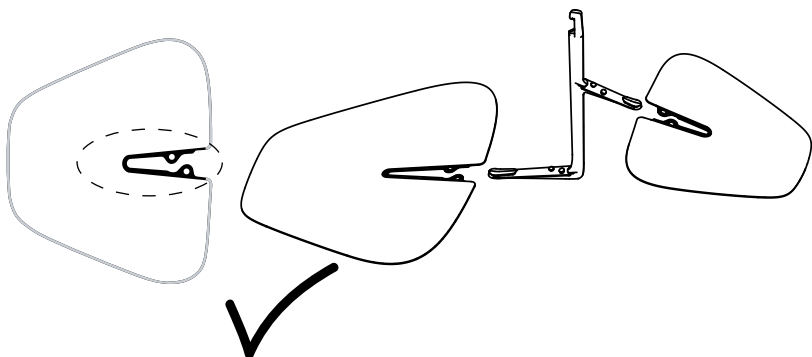
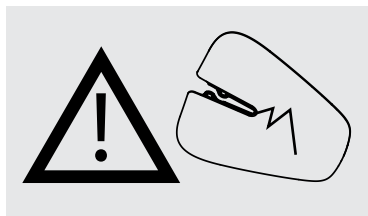

3.1

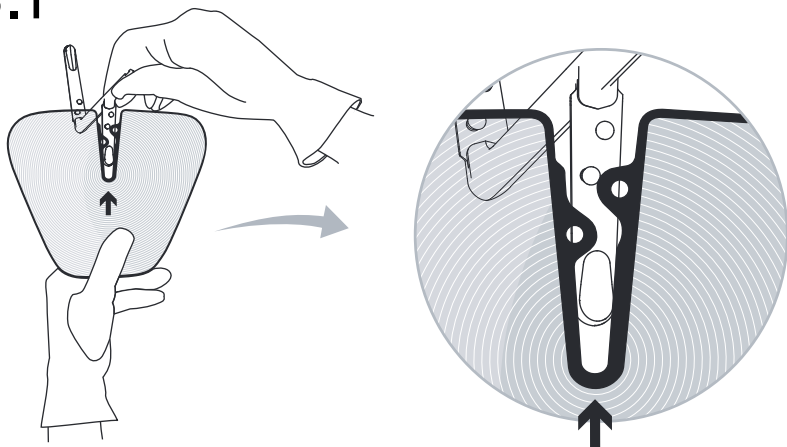

3.2

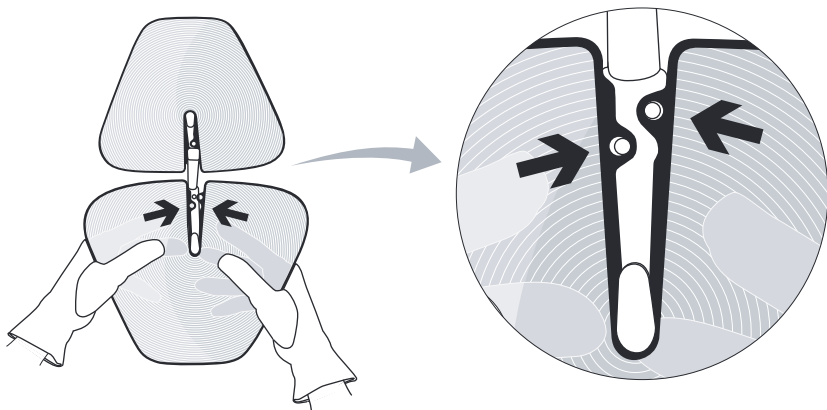

4

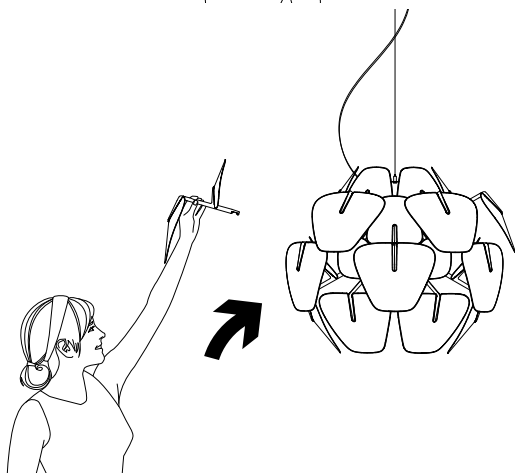
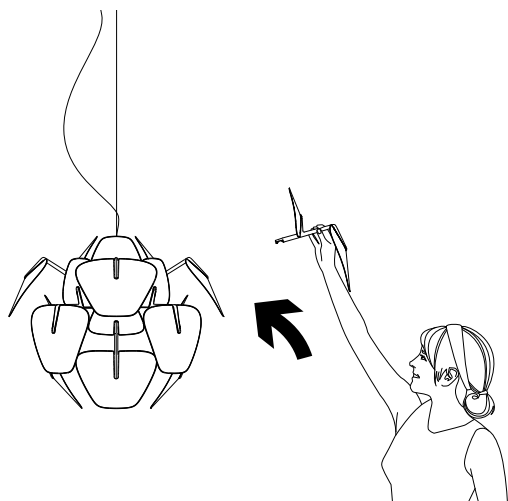

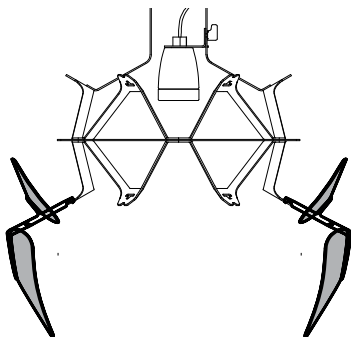

1.

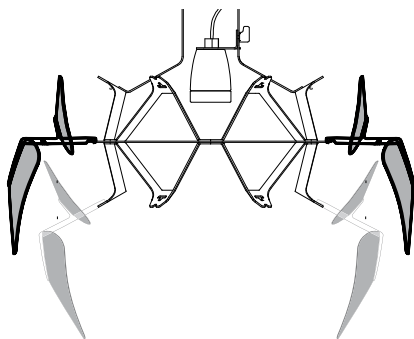

2.

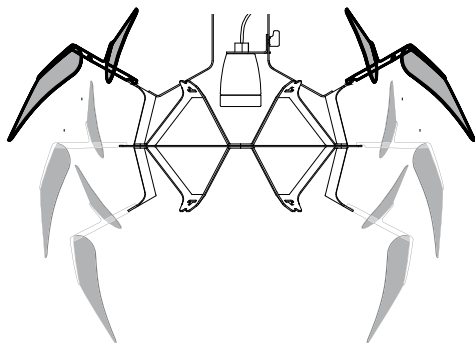

3.

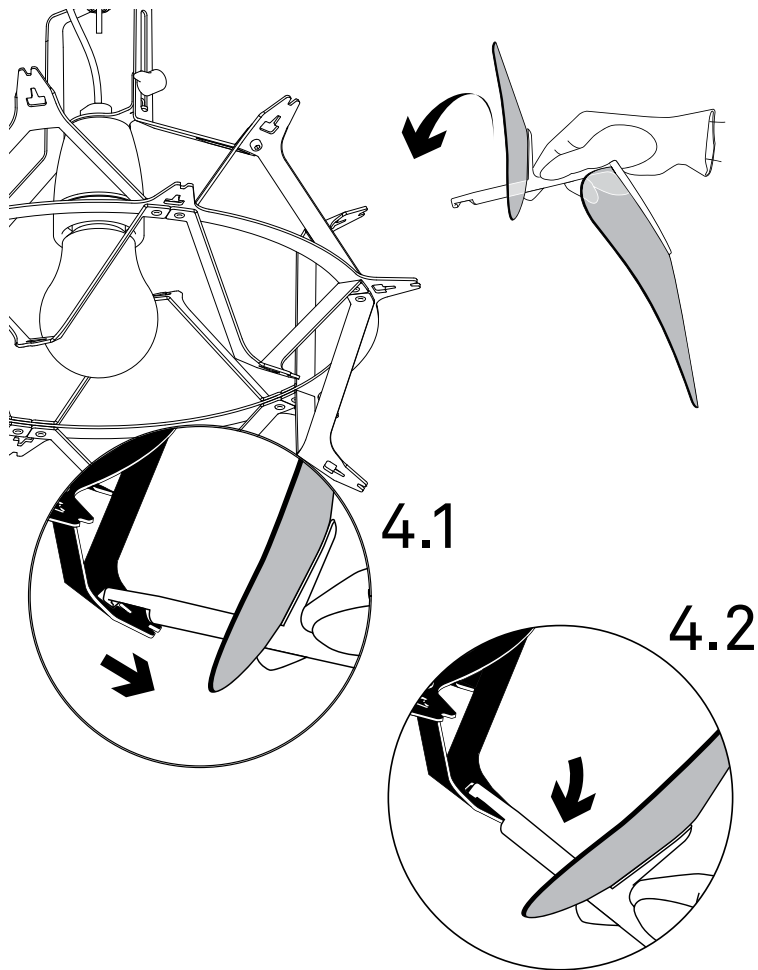

5

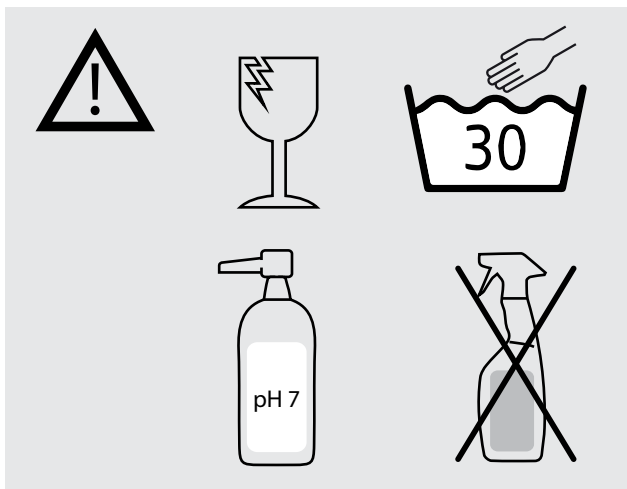
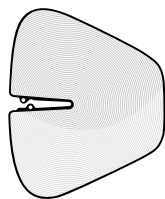
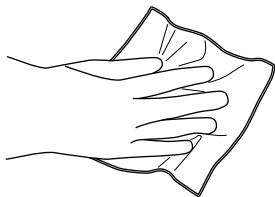

x1

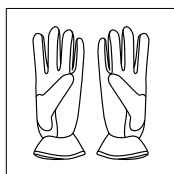

x2

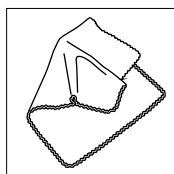

5.1

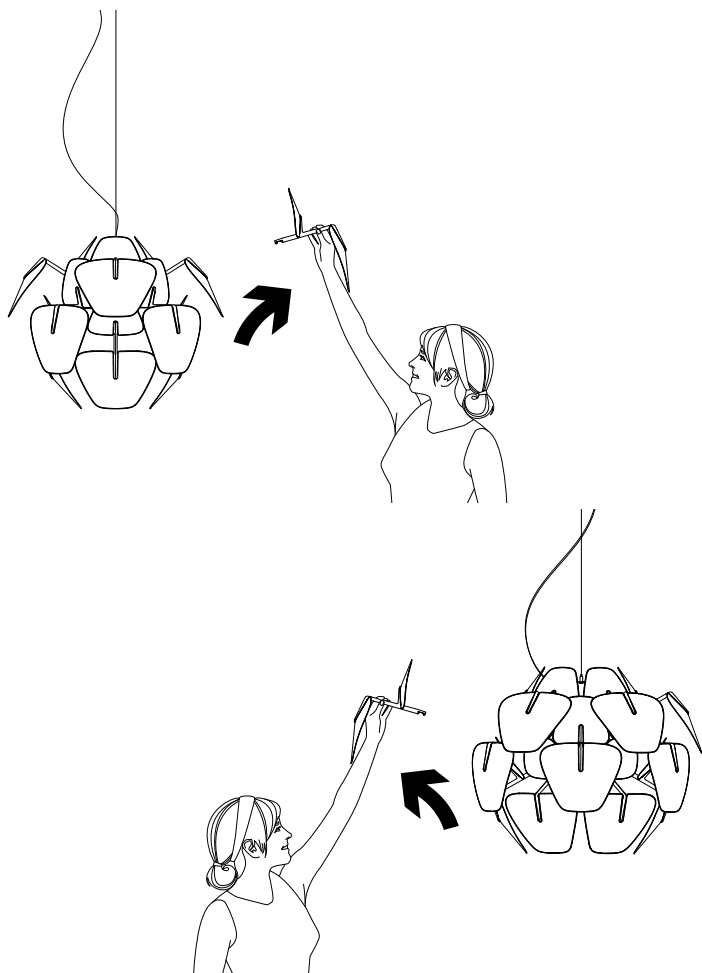

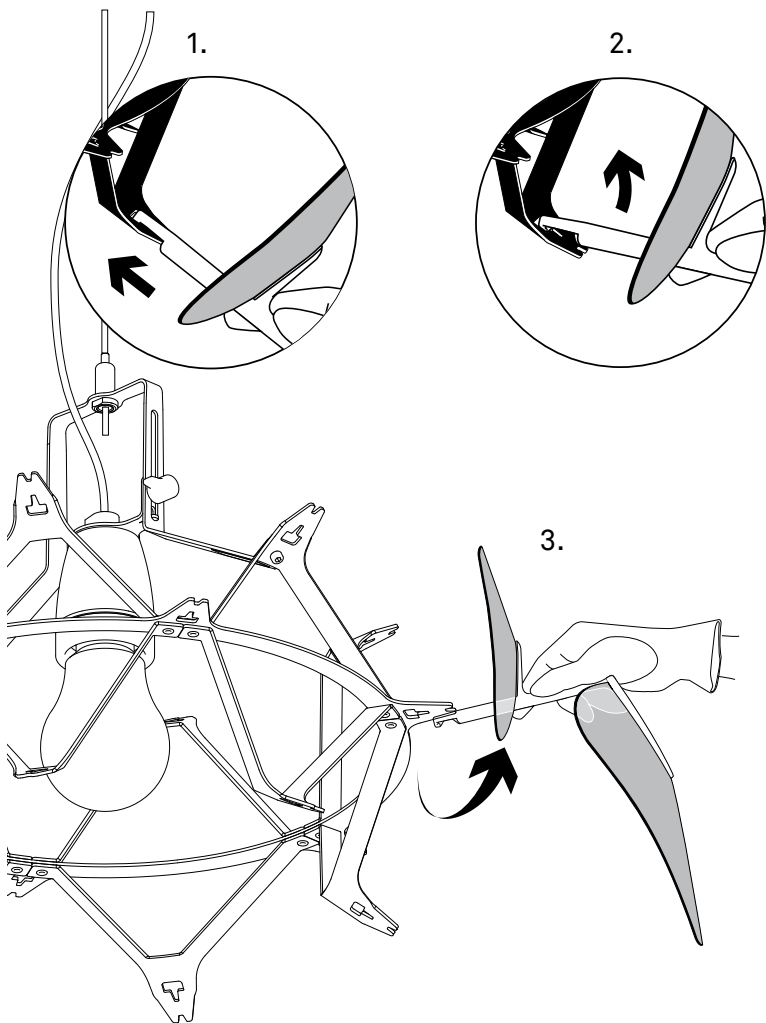

5.2

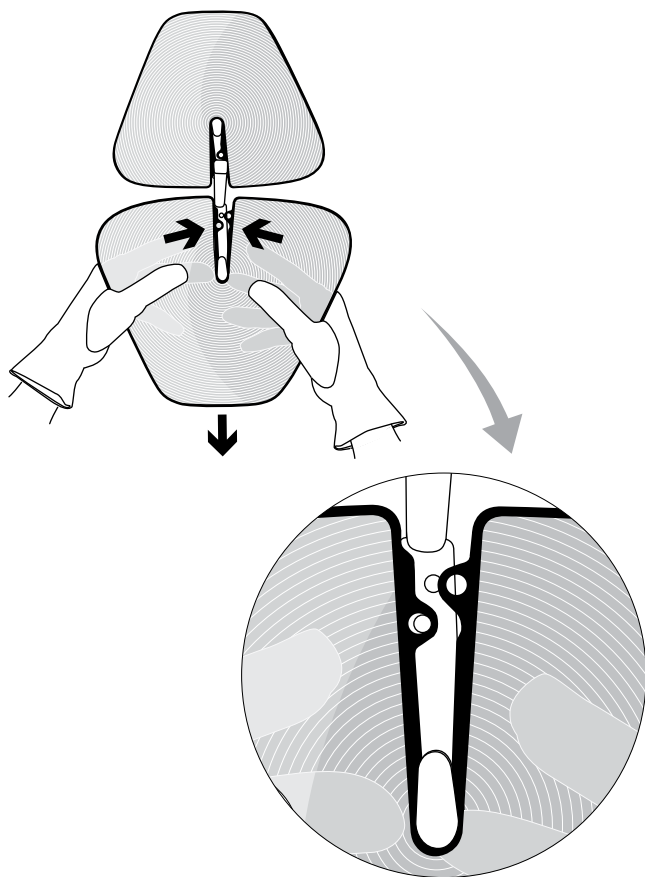

5.3

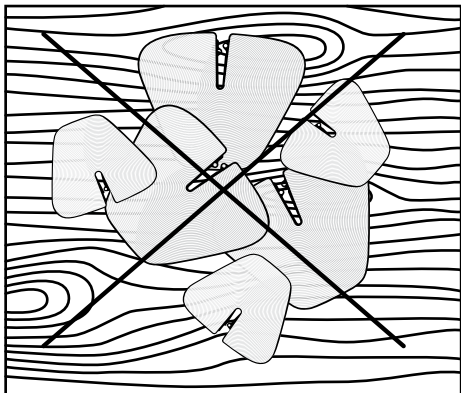

X

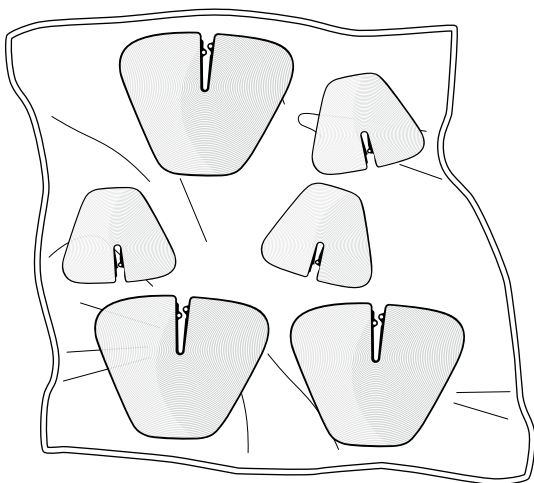

✓

5.4

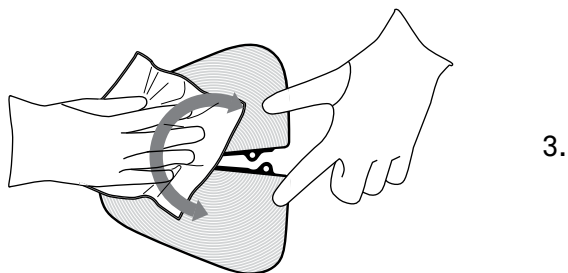
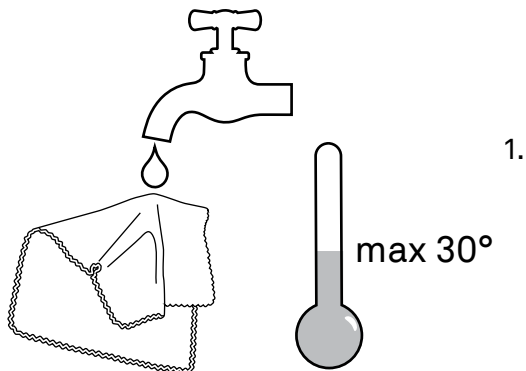

→ 3 |
(p. 19)



www.luceplan.com

D660I0211