

7620116
33W + 4W LED

incl. LED Board: L9001887

230V ~ 50Hz

(DE) Bestimmungsgemäße Verwendung
(GB) Intended use / (FR) Utilisation conforme / (NL) Beoogd gebruik / (PL) Stosowanie zgodnie z przeznaczeniem / (NO) Riktig bruk / (DK) Korrekt brug / (SE) Avsedd användning / (FI) Määräystenmukainen käyttö
(IT) Impiego appropriato / (ES) Uso prescrito / (CZ) Použití v souladu s určením / (PT) Utilização correta / (GR) Ενδεδειγμένη χρήση

(DE) Ortsfeste Verwendung als Deckenleuchte im Innenbereich	(GB) Provided for stationary indoor use on ceilings
(FR) Installation fixe en tant qu'plafonnier, à l'intérieur	(NL) Vast gebruik als plafondlamp binnenshuis
(PL) Do montażu stacjonarnego jako lampa sufitowa do wnętrza	(NO) Til stasjonært bruk som taklampe innendørs
(DK) Til stationær brug som loftlampe indendørs	(SE) Används som fast taklampa inomhus
(FI) Kiinteä käyttö sisätilojen kattovalaisimena	(IT) Impiego fisso come plafoniera in ambienti interni
(ES) Empleo fijo como lámpara de techo en interiores	(CZ) Stacionární použití jako stropní svítidlo v interiéru
(PT) Aplicação fixa como luminária de teto em interiores	(GR) Σταθερή χρήση ως φωτιστικό οροφής σε εσωτερικό χώρο

(DE) Verwendete Symbole
(GB) Safety Precautions / (FR) Symboles utilisés / (NL) Gebruikte symbolen / (PL) Stosowane symbole / (NO) Brukte symboler / (DK) Brugte symboler / (SE) Använda symboler / (FI) Käytetyt symbolit / (IT) Simboli usati / (ES) Símbolos empleados / (CZ) Použité symboly / (PT) Símbolos utilizados / (GR) Χρησιμοποιούμενα σύμβολα

IP 20

(DE) Lieferumfang
(GB) Package contents / (FR) Contenu de la livraison / (NL) Bij de levering inbegrepen / (PL) Zakres dostawy / (NO) Leveringsomfang / (DK) Leveringsomfang / (SE) Leveransomfattning / (FI) Toimitussisältö / (IT) Fornitura / (ES) Volumen de suministro / (CZ) Rozsah dodávky / (PT) Material fornecido / (GR) Παραδοτέος εξοπλισμός

(DE) 1 Deckenleuchte Montagematerial Montageanleitung	(GB) 1 Ceiling lamp Installation hardware Mounting instructions	(FR) 1 Plafonnier Matériel de montage Instructions de montage
(NL) 1 Plafondlamp Monteringsmateriale Montagehandleiding	(PL) 1 Lampa sufitowa Elementy montażowe Instrukcja montażu	(NO) 1 Taklampe Monteringsmateriale Brukerveiledning
(DK) 1 Loftlampe Monteringsmateriale Brugervejledning	(SE) 1 Taklampa Monteringsmaterial Monteringsanvisning	(FI) 1 Kattovalaisin Asennusmateriaali Asennusohjeet
(IT) 1 Plafoniera Materiale di montaggio Istruzioni di montaggio	(ES) 1 Lámpara de techo Material de montaje Instrucciones de montaje	(CZ) 1 Stropní svítidlo Materiál pro montáž Návod k montáži
(PT) 1 Luminária de teto Material de montagem Instruções de montagem	(GR) 1 Φωτιστικό οροφής Υλικά συναρμολόγησης Οδηγίες συναρμολόγησης	

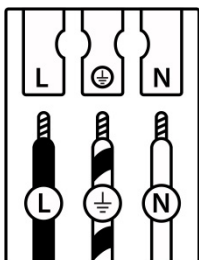
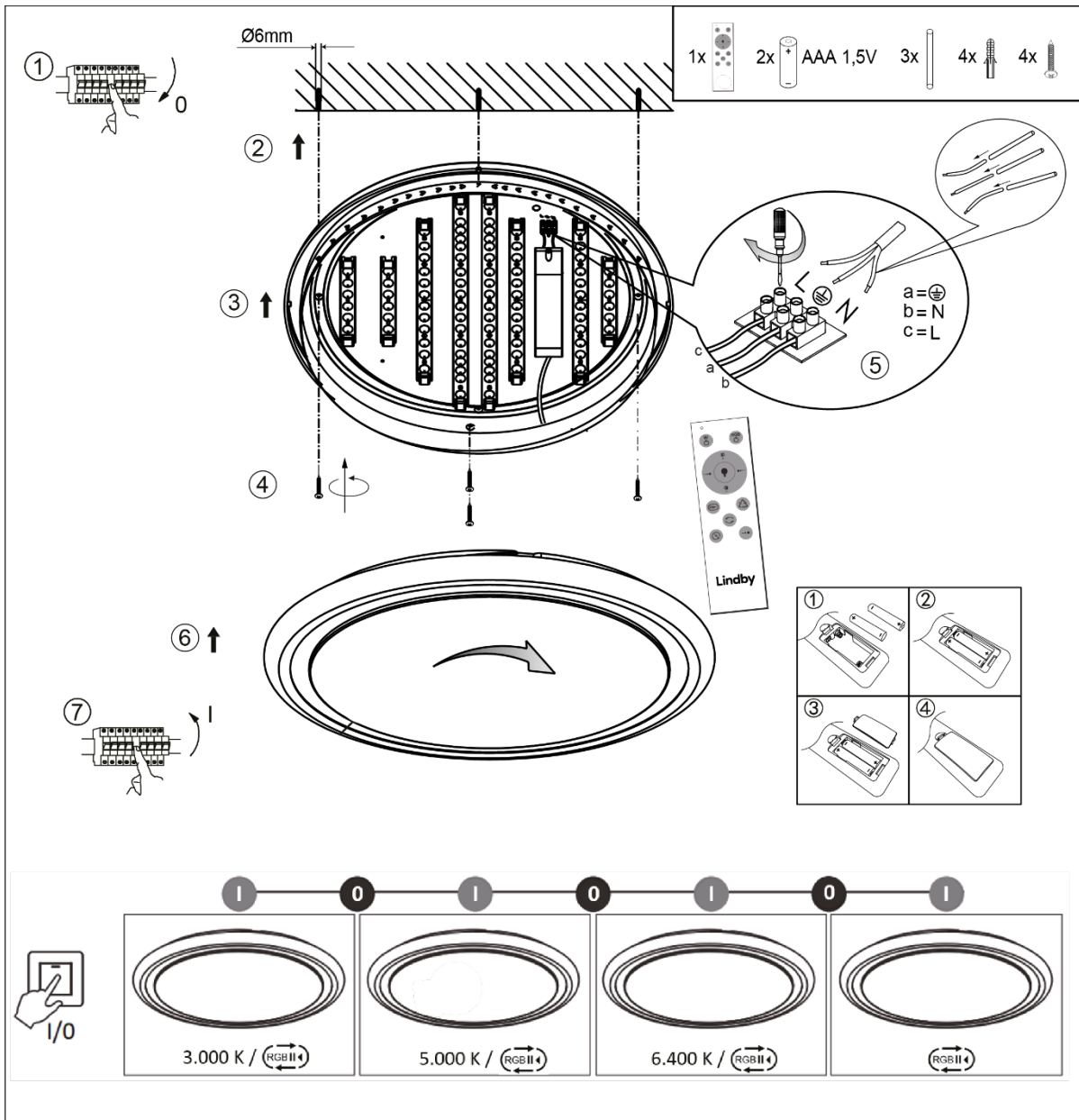

	(DE)	(GB)	(FR)	(NL)	(PL)	(NO)	(DK)
L	Stromführender Leiter	Live conductor	Conducteur	Spanningvoerende draad	Przewód prądowy	Strømførende leder	Strømførende leder
	Schutzleiter	Earth conductor	Conducteur de protection (terre)	Aardkabel	Przewód uziemiający	Jordledningen	Jordledningen
N	Neutralleiter	Neutral conductor	Conducteur neutre	Nulleider	Przewód zerowy	Nøytralleder	Neutralleider

	(SE)	(FI)	(IT)	(ES)	(CZ)	(PT)	(GR)
L	Strömförande ledare	Virtajohdin	Conduttore sotto tensione	Conductor de corriente	Vodič pod napětím	Condutor vivo	Ρευματοφόρος αγωγός
	Skyddsledare	Suojajohdin	Conduttore di terra	Conductor de protección	Ochranný vodič	Condutor de terra	Αγωγός γείωσης
N	Neutralledare	Nollajohdin	Conduttore neutro	Conductor neutro	Neutrální vodič	Condutor neutro	Ουδέτερος αγωγός

Bedienung über die Fernbedienung

1. Einschalten / Ausschalten der weißen LEDs
2. Einschalten / Ausschalten der RGB LEDs
3. Halten: Die Helligkeit der weißen LEDs wird langsam erhöht (bis 100%).
Kurz drücken: Die Helligkeit der weißen LEDs wird stufenweise erhöht.
4. Nachtlicht (ca. 10% der Helligkeit der weißen LEDs)
5. Halten: Die Leuchte wechselt langsam von warmen zu kaltem Licht.
Kurz drücken: Die Leuchte wechselt stufenweise von warmen zu kaltem Licht.
6. Halten: Die Leuchte wechselt langsam von kaltem zu warmen Licht.
Kurz drücken: Die Leuchte wechselt stufenweise von kaltem zu warmen Licht.
7. Halten: Die Helligkeit der weißen LEDs reduziert sich langsam (bis 10%). Kurz drücken: Die Helligkeit der weißen LEDs wird stufenweise reduziert.
8. Automatischer Farbdurchlauf (Rot / Grün / Blau / Mischfarben)
9. Farbwahl (Rot / Grün / Blau / Gelb / Lila)
10. Alle Leuchten, die sich in dem Infrarot Bereich der Fernbedienung befinden, werden auf die gleiche Farbtemperatur eingestellt, die zuletzt mit der Fernbedienung ausgewählt wurde.
11. 3-stufige Farbtemperatur (3000 Kelvin / 4000 Kelvin / 5000 Kelvin)
12. Timer Funktion (Die Leuchte schaltet sich nach 30 Sekunden aus.)

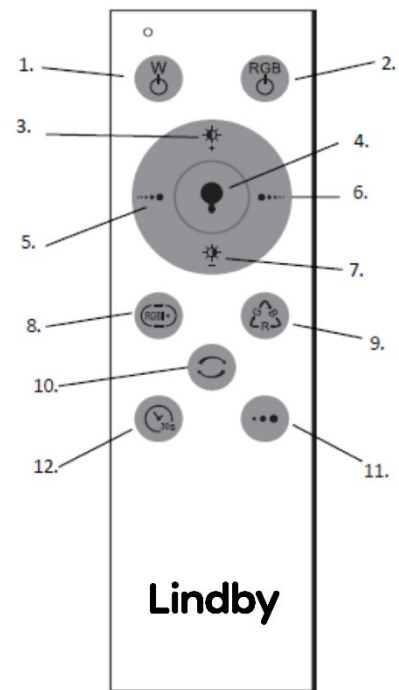

Bedienung über einen Wandschalter

1. Memory Funktion: Wird die Leuchte über einen Wandschalter aus und nach >3 Sekunden wieder eingeschaltet, leuchtet Sie in dem zuletzt eingestellten Modus (Farbe, Farbtemperatur, Helligkeit)
2. CCT: Durch mehrmaliges schnelles Ein- und Ausschalten kann die Farbtemperatur 3 stufig geändert werden: 3000 Kelvin / 5000 Kelvin / 6400 Kelvin.

Handling via remote control

1. ON / OFF the white LEDs
2. ON / OFF the RGB LEDs
3. Press the button for long time, you can increase the brightness of the lamp continuously (up to 100%).
Press the button shortly, you can increase the brightness of the lamp stepwise.
4. Nightlight (approx. 10% of the brightness)
5. Press the button for long time, you can change the color temperature of the light slowly from warm white to cold white.
Press the button shortly, you can change the color temperature of the light stepwise from warm white to cold white.
6. Press the button for long time, you can change the color temperature of the light slowly from cold white to warm white.
Press the button shortly, you can change the color temperature of the light stepwise from cold white to warm white.
7. Press the button for long time, you can reduce the brightness of the white LEDs slowly (to 10%).
Press the button for shortly, you can reduce the brightness of the white LEDs stepwise.
8. automatic color flow (red / green / blue / mixed colors)
9. color selection (red / green / blue / yellow / purple)
10. All lights in the infrared range of the remote control will be set to the same color temperature which was selected lastly with the remote control.
11. 3-Steps color temperature (3000 Kelvin / 4000 Kelvin / 5000 Kelvin)
12. Timer function (The light turns off after 30 seconds.)

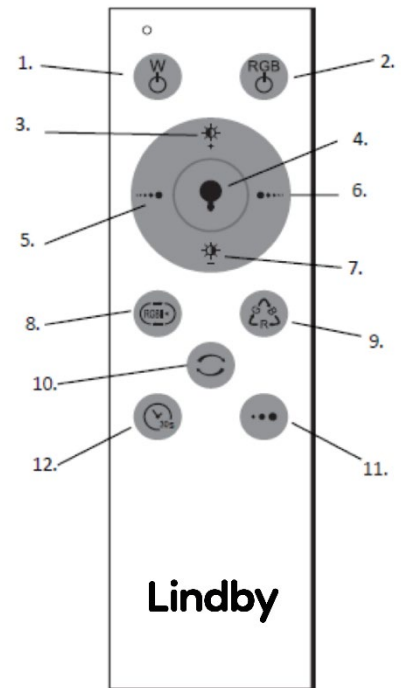

Handling via wall switch

1. Memory function: If you turn off the light via wall switch and turn on after >3 seconds the light lights up in the last mode (color temperature, brightness).
2. CCT: The color temperature can be changed in 3 steps by switching on / off several times quickly: 3000 Kelvin / 4000 Kelvin / 5000 Kelvin.

	QR	EAN
<p>(DE) Dieses Produkt enthält eine Lichtquelle der Energieeffizienzklasse E</p> <p>(EN) This product contains a light source of energy efficiency class E</p> <p>(FR) Ce produit comprend une source de lumière de classe d'efficacité énergétique E</p> <p>(NL) Dit product bevat een lichtbron van energie-efficiëntieklasse E</p> <p>(PL) Produkt ten zawiera źródło światła o klasie efektywności energetycznej E</p> <p>(NO) Dette produktet inneholder en lyskilde i energieeffektivitetsklasse E</p> <p>(DK) Dette produkt indeholder en lyskilde af energieeffektklasse E</p> <p>(SE) Denna produkt innehåller en ljuskälla i energieffektivitetsklass E</p> <p>(FI) Tämä tuote sisältää energiatehokkuusluokan E valonlähteen</p> <p>(IT) Questo prodotto contiene una sorgente luminosa della classe di efficienza energetica E</p> <p>(ES) Este producto contiene una fuente de luz de la clase de eficiencia energética E</p> <p>(CZ) Tento výrobek obsahuje světelný zdroj třídy energetické účinnosti E</p> <p>(PT) Este produto contém uma fonte de luz da classe de eficiência energética E</p> <p>(GR) Αυτό το προϊόν περιέχει μια φωτεινή πηγή ενεργειακής απόδοσης κλάσης E</p> <p>(SK) Tento výrobok obsahuje zdroj svetla triedy energetickej efektivity E</p>		<p>4251911734492</p>

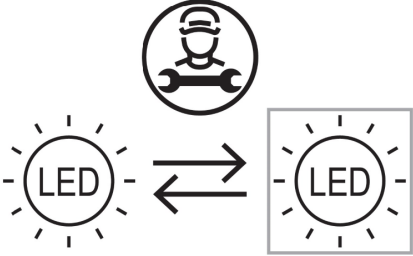
	<p>(DE) Durch einen Fachmann austauschbare Lichtquelle (nur LED)</p> <p>(EN) Replaceable (LED only) light source by a professional.</p> <p>(FR) Source de lumière remplaçable (LED uniquement) par un professionnel.</p> <p>(NL) Lichtbron (alleen led) te vervangen door een professional.</p> <p>(PL) Wymienne (tylko LED) źródło światła wykonane przez profesjonalistę.</p> <p>(NO) Utskiftbar (kun LED) lyskilde av en profesjonell.</p> <p>(DK) Udskiftelig lyskilde (kun LED), udskiftes af en elektriker.</p> <p>(SE) Ljuskälla (endast LED) utbytbar genom fackman.</p> <p>(FI) Ammattilainen voi vaihtaa vaihdettavan (vain LED) valonlähteen.</p> <p>(IT) Sorgente luminosa (solo LED) sostituibile da un professionista.</p> <p>(ES) Fuente de luz (solo LED) sustituible por un profesional.</p> <p>(CZ) Vyměnitelný (pouze LED) světelný zdroj odborníkem.</p> <p>(PT) Luz LED (apenas LED) substituível por um profissional.</p> <p>(GR) Η πηγή φωτός (μόνο LED) να αντικαθίσταται από επαγγελματία.</p> <p>(SK) Zdroj svetla (iba LED) vymeniteľný prostredníctvom odborníka.</p>
--	--

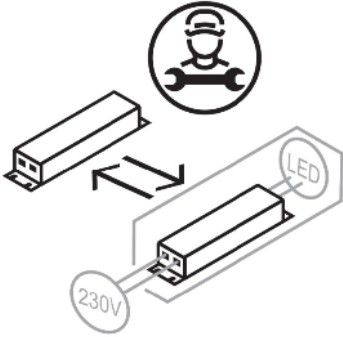
	<p>(DE) Durch einen Fachmann austauschbares Betriebsgerät.</p> <p>(EN) Replaceable control gear by a professional.</p> <p>(FR) Contrôleur remplaçable par un professionnel.</p> <p>(NL) Voorschakelapparatuur te vervangen door een professional.</p> <p>(PL) Wymienny układ sterujący przez profesjonalistę.</p> <p>(NO) Utskiftbar kontrollutstyr av en profesjonell.</p> <p>(DK) Udskiftelig igangsætter, udskiftes af en elektriker.</p> <p>(SE) Styrdon utbytbar genom fackman.</p> <p>(FI) Ammattilainen voi vaihtaa vaihdettavat ohjauslaitteet.</p> <p>(IT) Dispositivo di controllo sostituibile da un professionista.</p> <p>(ES) Dispositivo de control sustituible por un profesional.</p> <p>(CZ) Vyměnitelný předřadník odborníkem.</p> <p>(PT) Dispositivo de controlo substituível por um profissional.</p> <p>(GR) Ο εξοπλισμός ελέγχου να αντικαθίσταται από επαγγελματία.</p> <p>(SK) Predradník vymeniteľný prostredníctvom odborníka.</p>
---	---