

## 9956046

36W LED / 40W Total  
incl. 3x LED Board: L9002732  
230V ~ 50Hz

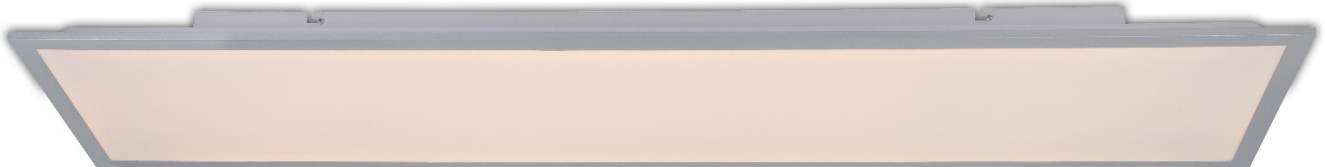

### (DE) Bestimmungsgemäße Verwendung

(GB) Intended use / (FR) Utilisation conforme / (NL) Beoogd gebruik / (PL) Stosowanie zgodne z przeznaczeniem /  
(NO) Riktig bruk / (DK) Korrekt brug / (SE) Avsedd användning / (FI) Määräystenmukainen käyttö  
(IT) Impiego appropriato / (ES) Uso prescrito / (CZ) Použití v souladu s určením / (PT) Utilização correta / (GR) Ενδεδειγμένη χρήση

|      |   |      |   |
|------|---|------|---|
| (DE) | Ortsfeste Verwendung als Deckenleuchte im Innenbereich  | (GB) | Provided for stationary indoor use on ceilings        |
| (FR) | Installation fixe en tant que plafonnier à l'intérieur  | (NL) | Vast gebruik als plafondlamp binnenshuis              |
| (PL) | Do montażu stacjonarnego jako lampa sufitowa do wnętrza | (NO) | Til stasjonært bruk som taklampe innendørs            |
| (DK) | Til stationær brug som loftlampe indendørs              | (SE) | Används som fast taklampe inomhus                     |
| (FI) | Kiinteä käyttö sisätilojen kattovalaisimena             | (IT) | Impiego fisso come plafoniera in ambienti interni     |
| (ES) | Empleo fijo en tanto lámpara de techo en interiores     | (CZ) | Stacionární použití jako stropní svítidlo v interiéru |
| (PT) | Aplicação fixa como luminária de teto em interiores     | (GR) | Σταθερή χρήση ως φωτιστικό οροφής σε εσωτερικό χώρο   |

### (DE) Verwendete Symbole

(GB) Safety Precautions / (FR) Symboles utilisés / (NL) Gebruikte symbolen / (PL) Stosowane symbole / (NO) Brukte symboler /  
(DK) Brugte symboler / (SE) Använda symboler / (FI) Käytetyt symbolit / (IT) Simboli usati / (ES) Símbolos empleados /  
(CZ) Použité symboly / (PT) Símbolos utilizados / (GR) Χρησιμοποιούμενα σύμβολα

IP 20



### (DE) Lieferumfang

(GB) Package contents / (FR) Contenu de la livraison / (NL) Bij de levering inbegrepen / (PL) Zakres dostawy / (NO) Leveringsomfang / (DK) Leveringsomfang / (SE) Leveransomfattning / (FI) Toimitussisältö / (IT) Fornitura / (ES) Volumen de suministro / (CZ) Rozsah dodávky / (PT) Material fornecido / (GR) Παραδοτέος εξοπλισμός

|      |   |      |   |      |  |
|------|---|------|---|------|--|
| (DE) | 1 Deckenleuchte<br>Montagematerial<br>Montageanleitung                | (GB) | 1 Ceiling lamp<br>Installation hardware<br>Mounting instructions      | (FR) | 1 Plafonnier<br>Matériel de montage<br>Instructions de montage |
| (NL) | 1 Plafondlamp<br>Monteringsmateriale<br>Montagehandleiding            | (PL) | 1 Lampa sufitowa<br>Elementy montażowe<br>Instrukcja montażu          | (NO) | 1 Taklampe<br>Monteringsmateriale<br>Brukerveiledning          |
| (DK) | 1 Loftlampe<br>Monteringsmateriale<br>Brugervejledning                | (SE) | 1 Taklampe<br>Monteringsmaterial<br>Monteringsanvisning               | (FI) | 1 Kattovalaisin<br>Asennusmateriaali<br>Asennusohjeet          |
| (IT) | 1 Plafoniera<br>Materiale di montaggio<br>Istruzioni di montaggio     | (ES) | 1 Lámpara de techo<br>Material de montaje<br>Instrucciones de montaje | (CZ) | 1 Stropní svítidlo<br>Materiál pro montáž<br>Návod k montáži   |
| (PT) | 1 Luminária de teto<br>Material de montagem<br>Instruções de montagem | (GR) | 1 Φωτιστικό οροφής<br>Υλικά συναρμολόγησης<br>Οδηγίες συναρμολόγησης  |      |  |

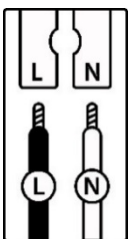
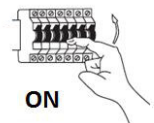
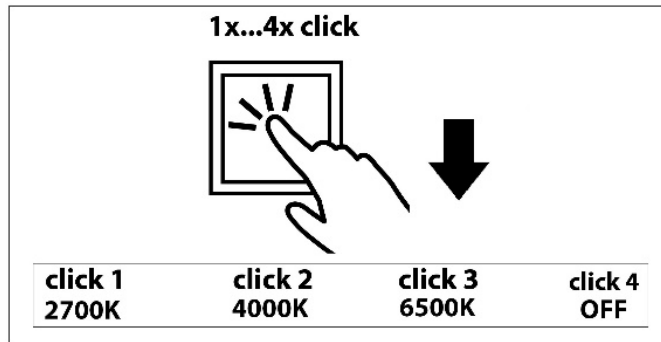
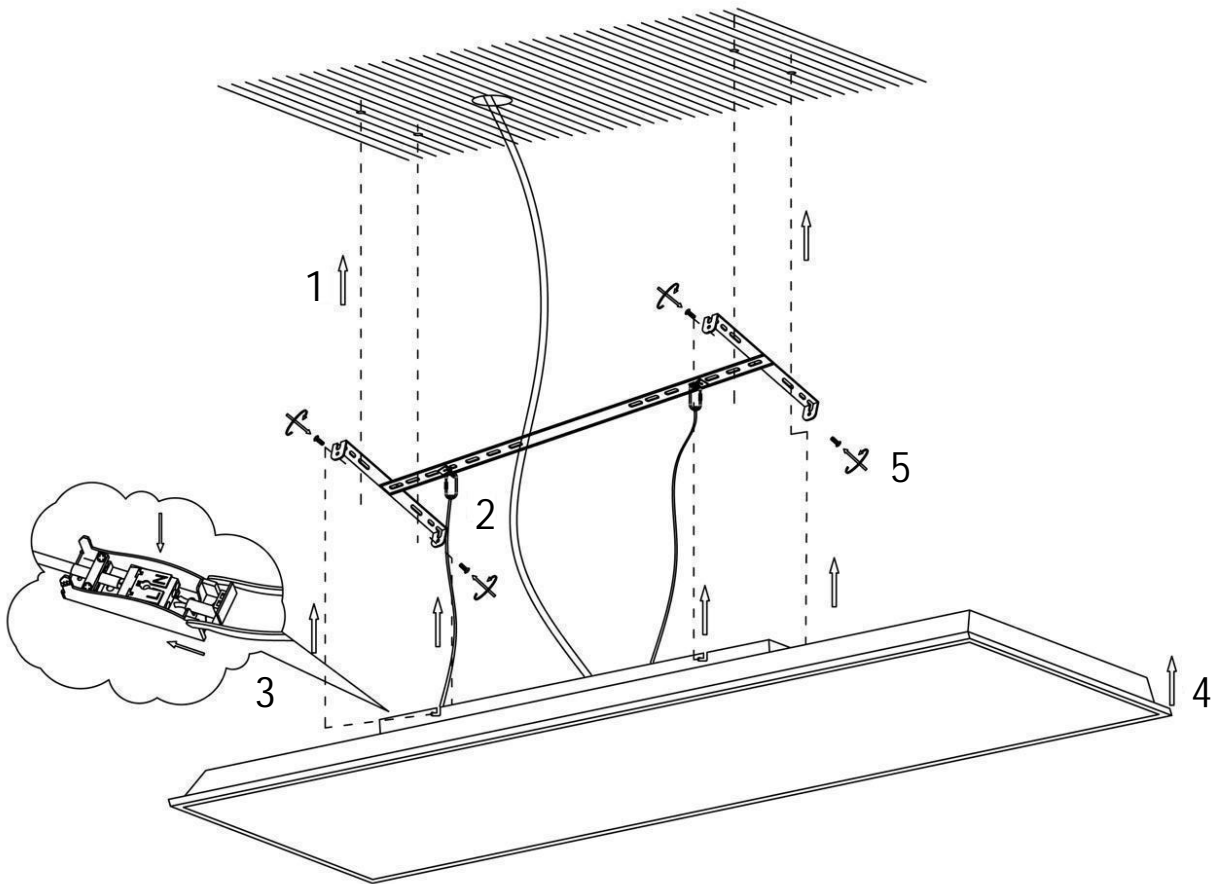
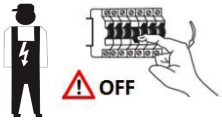

|          | (DE)                  | (GB)              | (FR)              | (NL)                   | (PL)            | (NO)               | (DK)               |
|----------|-----------------------|-------------------|-------------------|------------------------|-----------------|--------------------|--------------------|
| <b>L</b> | Stromführender Leiter | Live conductor    | Conducteur        | Spanningvoerende draad | Przewód prądowy | Strømførende leder | Strømførende leder |
| <b>N</b> | Neutralleiter         | Neutral conductor | Conducteur neutre | Nulleider              | Przewód zerowy  | Nøytralleider      | Neutralleider      |

|          | (SE)                | (FI)        | (IT)                      | (ES)                   | (CZ)              | (PT)            | (GR)                |
|----------|---------------------|-------------|---------------------------|------------------------|-------------------|-----------------|---------------------|
| <b>L</b> | Strömförande ledare | Virtajohdin | Conduttore sotto tensione | Conductor de corriente | Vodič pod napětím | Condutor vivo   | Ρευματοφόρος αγωγός |
| <b>N</b> | Neutralledare       | Nollajohdin | Conduttore neutro         | Conductor neutro       | Neutrální vodič   | Condutor neutro | Ουδέτερος αγωγός    |

|   |  |  |
|---|--|--|
| <p><b>(DE)</b> Dieses Produkt enthält eine Lichtquelle der Energieeffizienzklasse D<br/> <b>(EN)</b> This product contains a light source of energy efficiency class D<br/> <b>(FR)</b> Ce produit comprend une source de lumière de classe d'efficacité énergétique D<br/> <b>(NL)</b> Dit product bevat een lichtbron van energie-efficiëntieklasse D<br/> <b>(PL)</b> Produkt ten zawiera źródło światła o klasie efektywności energetycznej D<br/> <b>(NO)</b> Dette produktet inneholder en lyskilde i energieeffektivitetsklasse D<br/> <b>(DK)</b> Dette produkt indeholder en lyskilde af energieeffektklasse D<br/> <b>(SE)</b> Denna produkt innehåller en ljuskälla i energieffektivitetsklass D<br/> <b>(FI)</b> Tämä tuote sisältää energiatehokkuusluokan D valonlähteen<br/> <b>(IT)</b> Questo prodotto contiene una sorgente luminosa della classe di efficienza energetica D<br/> <b>(ES)</b> Este producto contiene una fuente de luz de la clase de eficiencia energética D<br/> <b>(CZ)</b> Tento výrobek obsahuje světelný zdroj třídy energetické účinnosti D<br/> <b>(PT)</b> Este produto contém uma fonte de luz da classe de eficiência energética D<br/> <b>(GR)</b> Αυτό το προϊόν περιέχει μια φωτεινή πηγή ενεργειακής απόδοσης κλάσης D<br/> <b>(SK)</b> Tento výrobok obsahuje zdroj svetla triedy energetickej efektivity D</p> | <p style="text-align: center;"><b>QR</b></p>  | <p style="text-align: center;"><b>EAN</b></p> <p style="text-align: center;">4251911773125</p> |
|---|--|--|

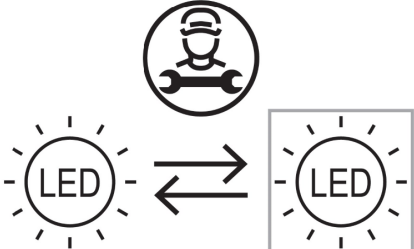
|  |   |
|--|---|
|  | <p><b>(DE)</b> Durch einen Fachmann austauschbare Lichtquelle (nur LED).<br/> <b>(EN)</b> Replaceable (LED only) light source by a professional.<br/> <b>(FR)</b> Source de lumière remplaçable (LED uniquement) par un professionnel.<br/> <b>(NL)</b> Lichtbron (alleen led) te vervangen door een professional.<br/> <b>(PL)</b> Wymienne (tylko LED) źródło światła wykonane przez profesjonalistę.<br/> <b>(NO)</b> Utskiftbar (kun LED) lyskilde av en profesjonell.<br/> <b>(DK)</b> Udskiftelig lyskilde (kun LED), udskiftes af en elektriker.<br/> <b>(SE)</b> Ljuskälla (endast LED) utbytbar genom fackman.<br/> <b>(FI)</b> Ammattilainen voi vaihtaa vaihdettavan (vain LED) valonlähteen.<br/> <b>(IT)</b> Sorgente luminosa (solo LED) sostituibile da un professionista.<br/> <b>(ES)</b> Fuente de luz (solo LED) sustituible por un profesional.<br/> <b>(CZ)</b> Vyměnitelný (pouze LED) světelný zdroj odborníkem.<br/> <b>(PT)</b> Luz LED (apenas LED) substituível por um profissional.<br/> <b>(GR)</b> Η πηγή φωτός (μόνο LED) να αντικαθίσταται από επαγγελματία.<br/> <b>(SK)</b> Zdroj svetla (iba LED) vymeniteľný prostredníctvom odborníka.</p> |
|--|---|

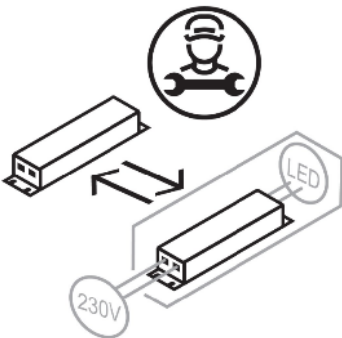
|   |   |
|---|---|
|  | <p><b>(DE)</b> Durch einen Fachmann austauschbares Betriebsgerät.<br/> <b>(EN)</b> Replaceable control gear by a professional.<br/> <b>(FR)</b> Contrôleur remplaçable par un professionnel.<br/> <b>(NL)</b> Voorschakelapparatuur te vervangen door een professional.<br/> <b>(PL)</b> Wymienny układ sterujący przez profesjonalistę.<br/> <b>(NO)</b> Utskiftbar kontrollutstyr av en profesjonell.<br/> <b>(DK)</b> Udskiftelig igangsætter, udskiftes af en elektriker.<br/> <b>(SE)</b> Styrdon utbytbar genom fackman.<br/> <b>(FI)</b> Ammattilainen voi vaihtaa vaihdettavat ohjauslaitteet.<br/> <b>(IT)</b> Dispositivo di controllo sostituibile da un professionista.<br/> <b>(ES)</b> Dispositivo de control sustituible por un profesional.<br/> <b>(CZ)</b> Vyměnitelný předřadník odborníkem.<br/> <b>(PT)</b> Dispositivo de controlo substituível por um profissional.<br/> <b>(GR)</b> Ο εξοπλισμός ελέγχου να αντικαθίσταται από επαγγελματία.<br/> <b>(SK)</b> Predradník vymeniteľný prostredníctvom odborníka.</p> |
|---|---|