

Artikel Nr.: 620021

Möbelaufbauleuchte, Spiegel Line II, 2er Bundle



Lieferumfang

Artikel Nr.	Bezeichnung	Anschlußmöglichkeit	Menge
687133	Möbelaufbauleuchte, Spiegel Line I, silberfarben, 12V DC, 12,00 W, Warmweiß	1,5 m Anschlußkabel mit Mini AMP Stecker	2
862170	Netzgerät, DIM, CV, 12V 12-50W	1,9 m Anschlußkabel mit Netzstecker - primär 1,8 m Anschlußkabel mit 6er Mini AMP Verteiler - sekundär	1

Artikel No.: 620021

Surface mounted furniture lamp, Mirror Line II 2 Pack Bundle



Scope of Delivery

Artikel No.	Description	Connectivity	Quantity
687133	Surface mounted furniture lamp, Mirror Line I, silver, 12V DC, 12,00 W, warmwhite	1,5 m connection cable with mini AMP plug	2
862170	Netzgerät, DIM, CV, 12V 2,5-25W	1,9 m connection cable with Power plug - primary 1,8 m connection cable with sixfold mini AMP distributor - secondary	1

Artikel Nr.: 687133

Möbelaufbauleuchte, Spiegel Line II, silberfarben, 12V DC, 12,00 W, Warmweiß

Technische Daten

Charakteristik

Material	Aluminium
Farbe	silberfarben
Optik	Chrom
im Lieferumfang	mit Halterung für max. 10 mm Glasstärke 1x Adapter, 1,5m Anschlusskabel mit Mini AMP Stecker



Elektrische Daten

Leistung / Leistungsaufnahme	12,00 W / 12,00 W
Eingangsspannung	12V DC
Eingangsstrom	
Fassung / Sockel	
Anzahl Sockel	
Netzgerät	exkl. LED-Netzgerät
Ansteuerung	nicht dimmbar
Anschlussmöglichkeit	Mini AMP Stecker
Schutzklasse I, II, III	III

Lichttechnische Eigenschaften

Leuchtmittel	LED-Modul fest
Lichtfarbe	Warmweiß
Farbtemperatur	3000 K
Lichtstrom	550 lm
Abstrahlwinkel	120°
LED Typ	SMD
LED Anzahl	66
Strahlungsverteilung	583 nm



Artikel Nr.: 687133

Möbelaufbauleuchte, Spiegel Line II, silberfarben, 12V DC, 12,00 W, Warmweiß

Lichtrichtung

Dreh- und Schwenkbereich	feststehend
Neigungswinkel	
Abstrahlverhalten	
Reflektor / Linse	

Abmessungen und Gewicht

Länge	512 mm
Breite	100 mm
Höhe	67 mm
Durchmesser	
Einbautiefe	
Gewicht	575 g

Ausschnittsmaß

Länge	
Breite	
Durchmesser	

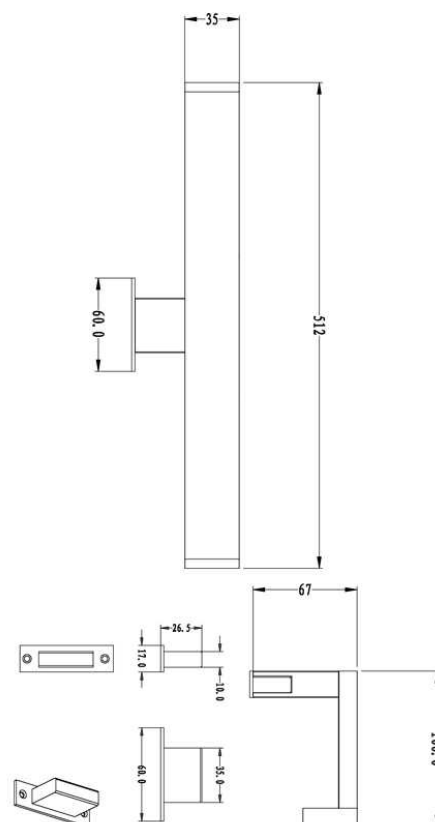

Artikel Nr.: 687133

Möbelaufbauleuchte, Spiegel Line II, silberfarben, 12V DC, 12,00 W, Warmweiß

Grenzwerte

Die Überschreitung der Grenzwerte und Betriebsspannung führt zu einer starken Verkürzung der Lebensdauer sowie Zerstörung der LED Module.

Betriebstemperatur	-5°C - +40°C
Lagertemperatur	-10°C - +40°C
IP - Schutzart	IP44



Allgemeine Eigenschaften

Umwelteigenschaften

Energieeffizienzklasse	A
Energieverbrauch	12 kWh/1000h

Lebensdauer

Lebensdauer	30000 h
Lichtstrom Ende Lebensdauer	0,70
Schaltzyklen	15000

IP44	Schutz gegen das Eindringen von Fremdkörper > 1 mm. Geschützt gegen Spritzwasser.
	Leuchte der Schutzklasse III Leuchte, bei der der Schutz gegen elektrischen Schlag auf der Anwendung der Schutzkleinspannung (SELV) beruht und in der Spannungen höher als SELV nicht erzeugt werden.
	Aufgrund des komplexen Herstellungsprozesses von LED stellen die angegebenen Werte nur rein statistische Größen dar und müssen nicht zwingend den tatsächlichen Parametern jedes einzelnen LED-Moduls entsprechen, sondern können von den typischen Werten abweichen.
	Die Lichtquelle dieser Leuchte darf nur vom Hersteller oder einem von ihm beauftragten Servicetechniker oder einer vergleichbar qualifizierten Person ersetzt werden

Article no.: 687133

Surface mounted furniture lamp, Mirror Line II, silver, 12V DC, 12,00 W, warmwhite

Technical Data**General Characteristics**

Material	aluminum
Colour	silver
Optics	chrome
included in delivery	with fixing bracket for max. 10 mm mirrorthickness 1x adaptor, 1,5m connection cable with mini AMP plug

**Electrical Characteristics**

Power / power consumption	12,00 W / 12,00 W
input voltage	12V DC
input current	
Base (standard designation)	
Number of bases	
Power supply unit	excl. LED-power supply unit
Electronically reversible	not dimmable
Connection possibility	Mini AMP plug
Protection class I, II, III	III

Light Technical Data

Bulb	LED-module fixed
Colour Designation	warmwhite
Colour temperature	3000 K
Luminous flux	550 lm
Beam angle	120°
LED type	SMD
LED quantity	66
Spectral power distribution	583 nm



Article no.: 687133

Surface mounted furniture lamp, Mirror Line II, silver, 12V DC, 12,00 W, warmwhite

Light Direction

Rotating and tilting range	fixed
Angle of inclination	
Radiation direction	
Reflector / lense	

Dimensions & Weight

Length	512 mm
Width	100 mm
Height	67 mm
Diameter	
Mounting Depth	
Product Weight	575 g

Cut-out dimensions

Length	
Width	
Diameter	

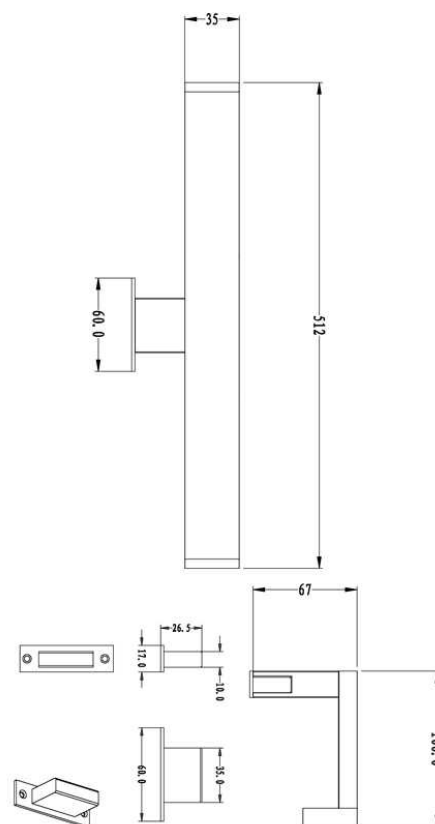

Article no.: 687133

Surface mounted furniture lamp, Mirror Line II, silver, 12V DC, 12,00 W, warmwhite

Absolute maximum ratings

The LED will get damaged and the lifetime will decrease when you overrun absolute maximum ratings.

Working temperature	-5°C - +40°C
Storage temperature	-10°C - +40°C
IP - Code	IP44



General product data

Environmental Characteristics

Energy label	A
Energy consumption	12 kWh/1000h

Lifespan

Lamp life time	30000 h
Luminous flux (end of lifetime)	0,70
Number of switching cycles	15000

IP44	Protection against penetration of foreign objects > 1 mm. Protection against penetration of splashing water.
	Lightings of Protection Class III Luminaire in which protection against electric shock relies on supply at safety extra-low voltage (SELV) and in which voltages higher than those of SELV are not generated.
	Because of the complex manufacturing process of the LED the above shown data are just a statistical size, which is not forced to be the realistic data of every LED.
	The light source of this luminaire may only be replaced by the manufacturer or by a service technician appointed by him or by a comparable qualified person

Artikel Nr.: 862170

Netzgerät, DIM, CV, 12V 12-50W











IP20 CE

Elektrische Daten

Betriebsart	spannungskonstant	Eingangsspannung	220-240V AC/50-60Hz
Leistung	12,00-50,00 W	Leistungsfaktor	>0,95
Ausgangsspannung	12V DC	Anschlußmöglichkeit	Anschlussbox
Ausgangsstrom	1000-4160 mA		

Produkteigenschaften

	Schutzklasse II		Überspannungsschutz
SELV	Schutzkleinspannung		Lampenbetriebsgerät 110
	Kurzschlußfest		Möbeleinbau geeignet
	Überlastschutz	ErP	Standby-Stromverbrauch < 0,5 W
	Übertemperaturschutz	LVD	Sicherheit nach EN 61347
	Sicherheitstrafo	EMC	Funkentstörung + Störfestigkeit nach EN 55015 + EN 61547
	dimmbar - Phasenanschnitt oder Phasenabschnitt	EMC	Netzstromoberwellen + Flicker nach EN 61000-3-2 + EN 61000-3-3

Schwarze Felder sind zutreffend / graue Felder sind nicht zutreffend

Artikel Nr.: 862170

Netzgerät, DIM, CV, 12V 12-50W

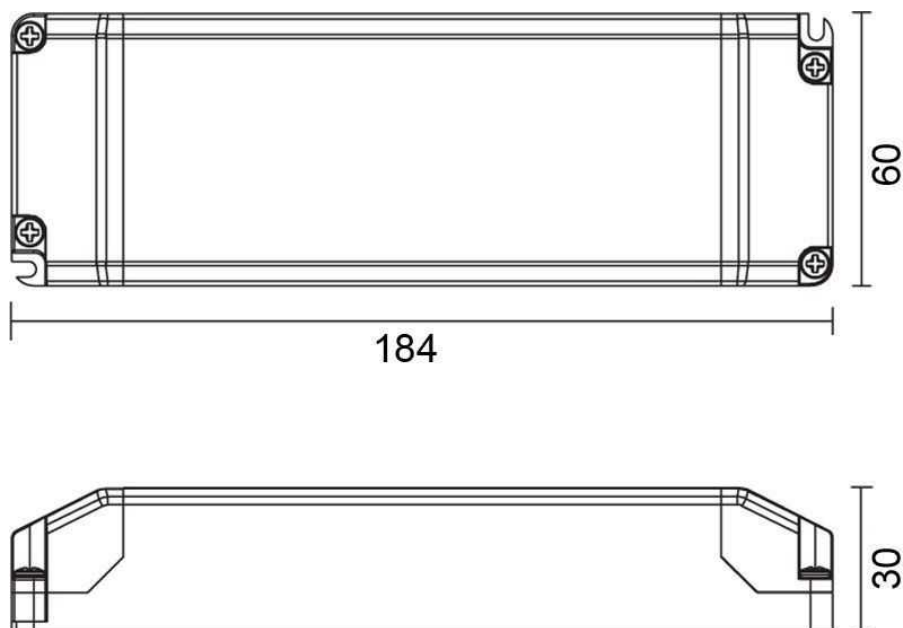
**Abmessungen und Gewicht****Grenzwerte**

Länge	184,00 mm	Betriebstemperatur	-20°C - +50°C
Breite	61,00 mm	Gehäusetemperatur	0 °C
Höhe	33,00 mm		
Durchmesser	0,00 mm		
Gewicht	240 g		

Article No.: 862170

Power supply unit, DIM, CV, 12V 12-50W











IP20 CE

Electrical Characteristics

Operating mode	constant voltage	Input voltage	220-240V AC/50-60Hz
Power	12,00-50,00 W	Power factor	>0,95
Output voltage	12V DC	Connection possibility	Connection box
Output current	1000-4160 mA		

Product features

	Protection class II		Overvoltage protection
SELV	Low voltage protection		Lamp control gear 110
	Short circuit protection		Suitable for furniture installation
	Overload protection	ErP	Standby-power consumption < 0,5 W
	Overheating protection	LVD	Safety according to EN 61347
	Safety transformer	EMC	Interference suppression + immunity according to EN 55015 + EN 61547
	dimnable - leading edge or trailing edge	EMC	Mains harmonics + flicker according to EN 61000-3-2 + EN 61000-3-3

Black fields are applicable / gray fields are not applicable

Article No.: 862170

Power supply unit, DIM, CV, 12V 12-50W

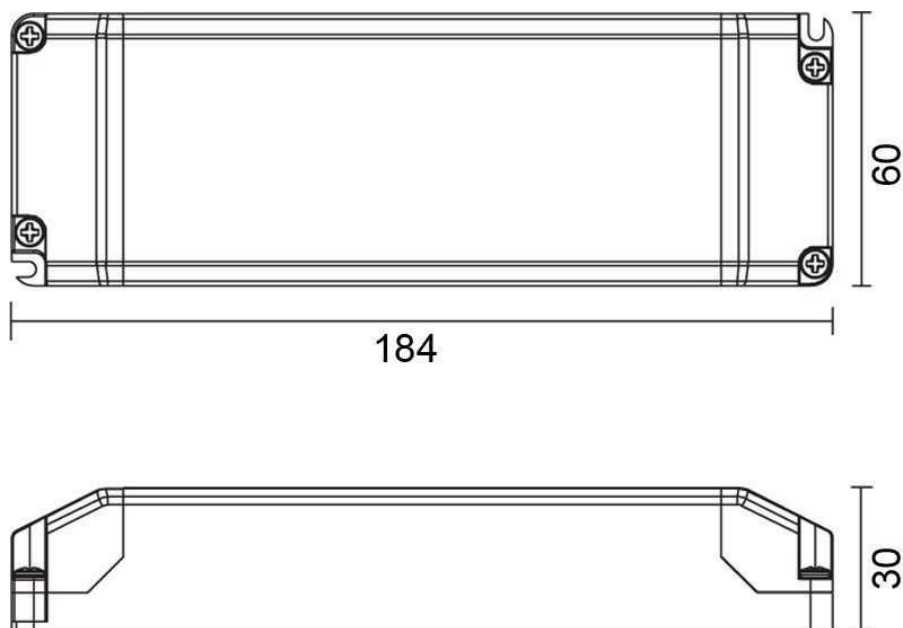
**Dimensions & Weight****Absolute maximum ratings**

Length	184,00 mm	Operating temperature	-20°C - +50°C
Width	61,00 mm	Case temperature	0 °C
Height	33,00 mm		
Diameter	0,00 mm		
Product weight	240 g		