

**BINATO LED recessed spot set, rotatable and pivoted, trailing-edge phase dimmable**

Article no. 39173727

Light.  
For Generations.

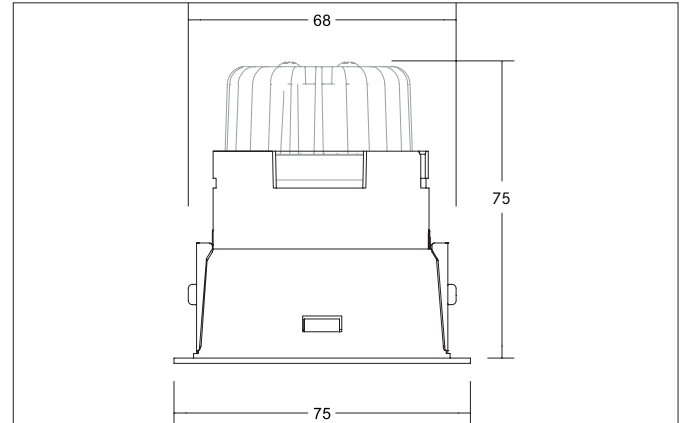

**Tender**  
LED recessed spot set, rotatable and pivoted, trailing-edge phase dimmable, Round. Toolless ceiling installation by leaf spring. Ceiling cut-out Ø 68 mm, Installation depth 75 mm, Outer diameter 75 mm, Weight 0,192 kg, Reflector silver with rotationssymmetrical, deep, wide distributed light intensity. optimal light distribution due to a glass transparent cover. Luminous flux 600 lm, Power 1 x 6 W, System Efficiency 100 lm/W, Light colour warm white, Correlated color temprature (CCT) 2.700 K, Colour rendering index CRI > 80, Housing material: Aluminium / Plastic, Colour: White structure, Permissible ambient temperature (ta): -20 °C - +25 °C, Protection class (EN 61140): III, Degree of protection (DIN EN 60529): IP20, .With electronic driver, Trailing-edge phase dimmable.

Article data	
Article no.	39173727
GTIN	4251433982043
Series name	BINATO
Short description	LED recessed spot set, rotatable and pivoted, trailing-edge phase dimmable
Material	Aluminium / Plastic
Colour	White
Type of surface	Structure
Shape	Round
Outer diameter	75 mm
Built-in diameter	68 mm
Installation depth	75 mm
Hight	2 mm
Scope of delivery	incl. leaf spring mounting
Weight	0.192 kg

**BINATO LED recessed spot set, rotatable and pivoted, trailing-edge phase dimmable**

Article no. 39173727

Light.  
For Generations.

Lighting technology	
Colour temperature	2.700 K
Light output	Direct
Luminous flux	600 lm
System efficiency	100 lm/W
Colour rendering	CRI > 80
Reflector	High-gloss
Reflektorfarbe	silver
Beam angle	38°
Light sharing	Symmetric
Adjustable color temperature	No

Operating technology of the luminaire	
System output	6 W
Voltage type	AC
AC nominal voltage max	230 V
Frequenz max.	50 Hz
Lamp	LED
Protection class	III
Degree of protection	IP20
Dimmable	Yes
Control	Trailing-edge phase
Bulb change possible	The light source of this luminaire may only be replaced by the manufacturer or a service technician commissioned by him or a similarly qualified person.

Mounting technology	
Mounting method	Recessed mounting
Place of installation	Ceiling-mounted
Adjustability	Rotatable and pivoted
Swivel angle	30°
Rotation angle	355°
Max. ceiling thickness	25 mm
Further references	No cover with thermal insulation material
Material cover	Glass transparent
Circlip	Without circlip
Suitable for through-wiring	Yes, with optional accessories

Packing data	
Gross weight	0.255 kg
Length of packaging	100 mm
Packaging width	100 mm
Packaging height	100 mm
Disposal at end of life	This product must not be disposed of with household waste. You are obliged, to dispose of such electrical waste separately. By disposing of electrical waste and other old or defective electronics separately, you support recycling or other forms of re-use. In that way you help to take care and to avoid that harmful substances get into the environment.