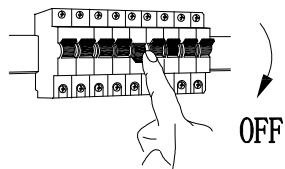
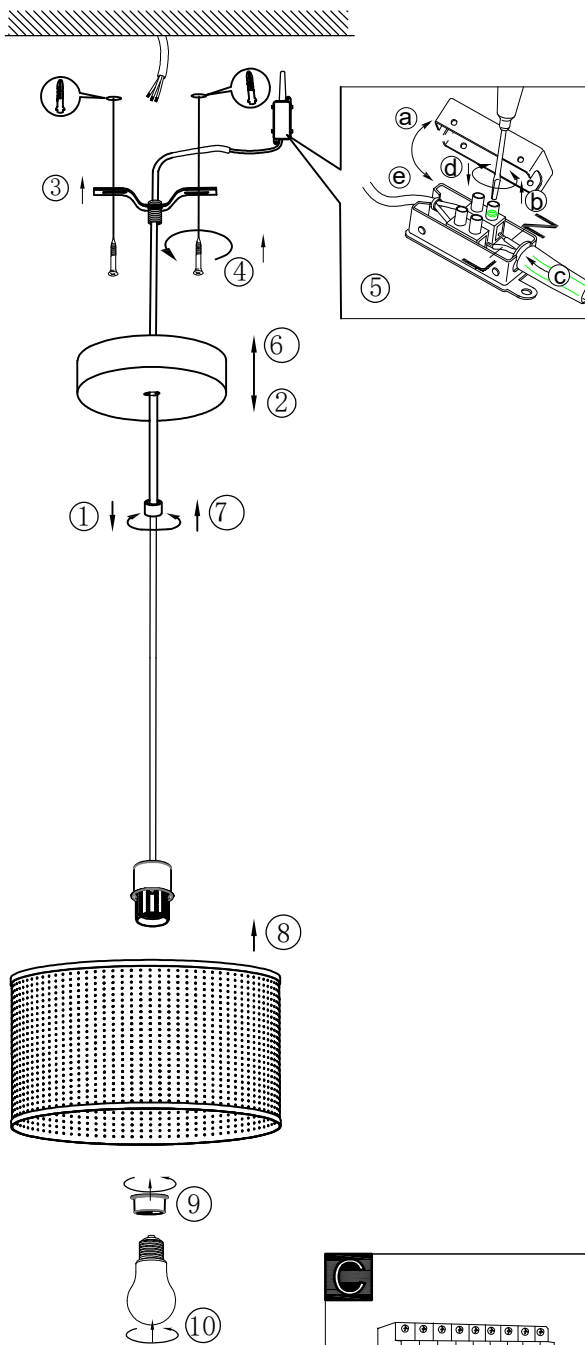
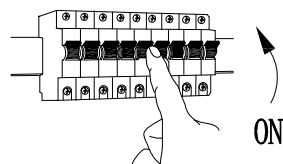

**A****B****C**

BLA43795  
www.eglo.com