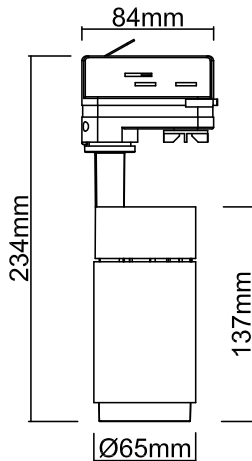

**9967115**

12W LED / 15W Total  
incl. LED Board: L9002442  
220-240V ~ 50Hz

**(DE) Bestimmungsgemäße Verwendung**

(GB) Intended use / (FR) Utilisation conforme / (NL) Beoogd gebruik / (PL) Stosowanie zgodnie z przeznaczeniem /  
(NO) Riktig bruk / (DK) Korrekt brug / (SE) Avsedd användning / (FI) Määräystenmukainen käyttö  
(IT) Impiego appropriato / (ES) Uso prescrito / (CZ) Použití v souladu s určením / (PT) Utilização correta / (GR) Ενδεδειγμένη χρήση

(DE)	Verwendung als Schienenstrahler im Innenbereich	(GB)	Provided for indoor use as track spotlight
(FR)	Utilisation comme spot sur rail à l'intérieur	(NL)	Gebruik als railstraler binnenshuis
(PL)	Do montażu jako reflektor szynowy do wnętrza	(NO)	Til bruk som skinnespot innendørs
(DK)	Til brug som strømskinne spot indendørs	(SE)	Används som skenspotlight inomhus
(FI)	Kohdevalaisin 1-vaihejärjestelmään	(IT)	Impiego fisso come spot per binario in ambienti interni
(ES)	Empleo fijo en tanto sistema de riel spot en interiores	(CZ)	Stacionární použití jako reflektor v interiéru
(PT)	Aplicação fixa como holofotes trilha em interiores	(GR)	Σταθερή χρήση ως φωτιστικό οροφής σε εσωτερικό χώρο

**(DE) Verwendete Symbole**

(GB) Safety Precautions / (FR) Symboles utilisés / (NL) Gebruikte symbolen / (PL) Stosowane symbole / (NO) Brukte symboler /  
(DK) Brugte symboler / (SE) Använda symboler / (FI) Käytetyt symbolit / (IT) Simboli usati / (ES) Símbolos empleados /  
(CZ) Použité symboly / (PT) Símbolos utilizados / (GR) Χρησιμοποιούμενα σύμβολα

IP 20

**(DE) Lieferumfang**

(GB) Package contents / (FR) Contenu de la livraison / (NL) Bij de levering inbegrepen / (PL) Zakres dostawy / (NO) Levering /  
(DK) Leveringsomfang / (SE) Leveransomfattning / (FI) Toimitussisältö / (IT) Fornitura / (ES) Volumen de suministro /  
(CZ) Rozsah dodávky / (PT) Material fornecido / (GR) Παραδοτέος εξοπλισμός

(DE)	1 Schienenstrahler Montagematerial Montageanleitung	(GB)	1 track spotlight Installation hardware Mounting instructions	(FR)	1 spot sur rail Matériel de montage Instructions de montage
(NL)	1 railstraler Monteringsmateriale Montagehandleiding	(PL)	1 reflektor szynowy Elementy montażowe Instrukcja montażu	(NO)	1 skinnespot Monteringsmateriale Brukerveiledning
(DK)	1 strømskinne spot Monteringsmateriale Brugervejledning	(SE)	1 skenspotlight Monteringsmaterial Monteringsanvisning	(FI)	1 Kohdevalaisin Asennusmateriaali Asennusohjeet
(IT)	1 spot per binario Materiale di montaggio Istruzioni di montaggio	(ES)	1 sistema de riel spot Material de montaje Instrucciones de montaje	(CZ)	1 Stropní svítidlo Materiál pro montáž Návod k montáži
(PT)	1 Luminária de teto Material de montagem Instruções de montagem	(GR)	1 Φωτιστικό οροφής Υλικό συναρμολόγησης Οδηγίες συναρμολόγησης		



## (DE) LED TRACK USER GUIDE

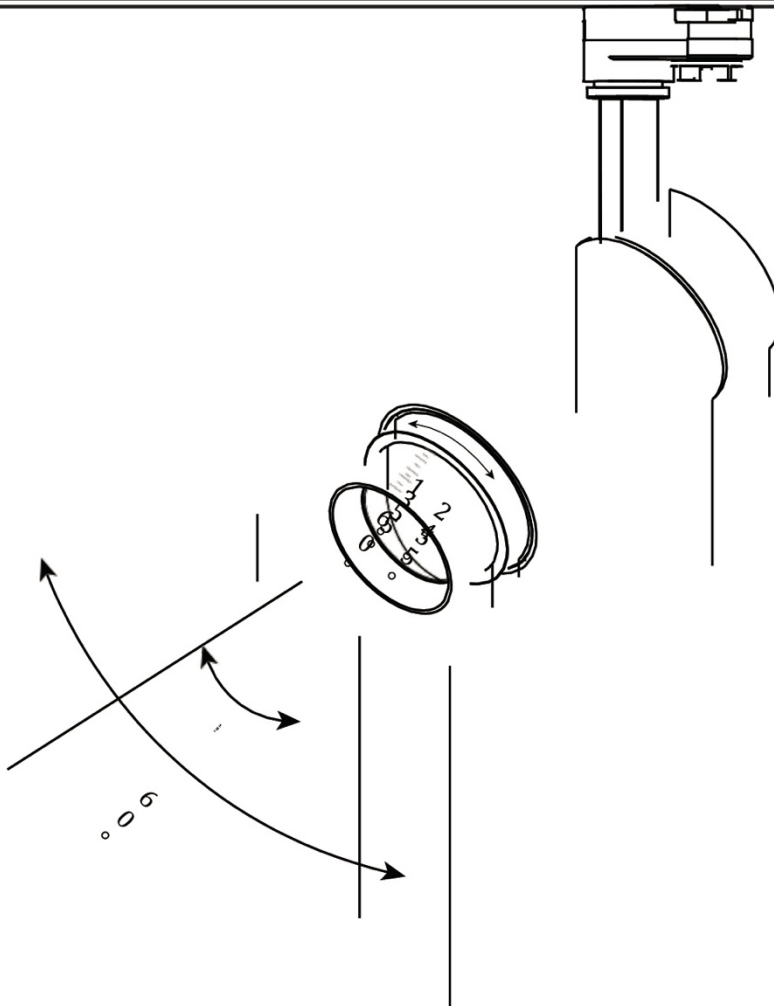

### LED TRACK LIGHT

Zoom lens adjustable manually: 15°-60°

## WICHTIGE SICHERHEITSAUWEISUNGEN

Bei der Installation oder Verwendung dieses Schienensystems sollten immer grundlegende Sicherheitsvorkehrungen getroffen werden, einschließlich der folgenden:

1. Lesen Sie alle Anweisungen.
2. Schneiden Sie keine Schienenabschnitte ab.
3. Nur für Innenräume geeignet. Installieren Sie diese Schiene nicht in feuchten oder nassen Räumen.
4. Installieren Sie keinen Teil des Schienensystems weniger als 5 Fuß über dem Boden.
5. Installieren Sie keine Leuchtenbaugruppe näher als 6 Zoll von einem Vorhang oder ähnlichem brennbaren Material entfernt.
6. Schalten Sie die Stromversorgung vor der Installation oder vor Wartungsarbeiten aus.
7. Überschreiten Sie nicht die Nennwerte der Versorgungsspannung oder Stromstärke.
8. Versuchen Sie nicht, etwas anderes als die Stromschienenleuchten an der Schiene unter Spannung zu setzen. Um die Gefahr von Bränden und elektrischen Schlägen zu verringern, dürfen Sie keine Elektrowerkzeuge, Verlängerungskabel, Geräte oder ähnliches an die Stromschiene anschließen.
9. Schließen Sie eine Stromschiene nicht an mehr als einen Stromkreis an, es sei denn, die Stromschiene ist so konstruiert, dass sie mit mehr als einem Stromkreis verwendet werden kann. Wenden Sie sich an einen qualifizierten Elektriker. Auch wenn die Stromschienenbeleuchtung scheinbar einwandfrei funktioniert, kann es zu einer gefährlichen Überlastung des Nulleiters kommen, was zu einer Brandgefahr führen kann.
10. Tragen Sie Schuhe mit Gummisohlen und arbeiten Sie auf einer stabilen Holzleiter oder einer nicht leitenden Leiter.
11. Das Produkt muss an einem Ort und in einer Höhe montiert werden, die dem Verwendungszweck entsprechen, und zwar in Übereinstimmung mit dem National Electrical Code und den örtlichen Bauvorschriften.
12. Die dimmbare Version kann mit einer Vielzahl von empfohlenen TRIAC-Dimmern kompatibel sein.

### Wählen Sie den Adapter, bevor Sie die Stromschiene kaufen

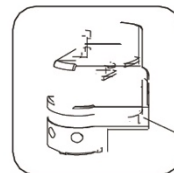
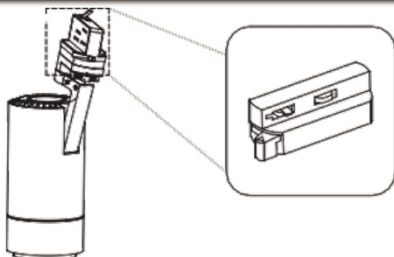

3-Drähte, 1-Schaltung

4-Drähte, 3-Schaltung

### Schaltplan der Gleisanlage

#### 2- Drähte, 1-Schaltung

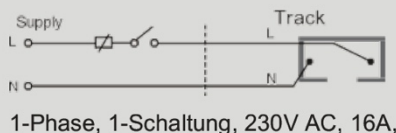

#### 3- Drähte, 1-Schaltung

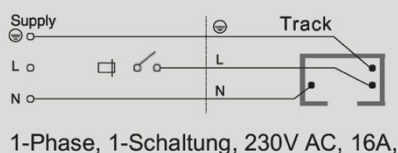

#### 4- Drähte, 3-Schaltung

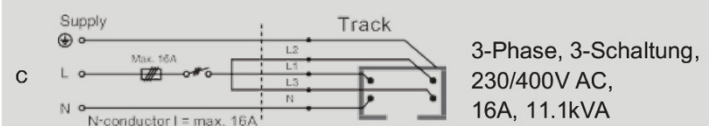
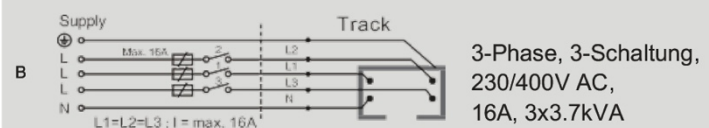

## Installationsverfahren

### WARNUNG

1. Schalten Sie das Gerät vor der Installation aus.
2. Erst nach vollständiger Installation und Prüfung des Stromkreises einschalten.
3. Nur von einer Elektrofachkraft installieren und warten lassen.



Turn Off  
Power Supply

### Schritt 1

Schalten Sie die Stromzufuhr aus, bevor Sie mit der Installation beginnen. Lesen Sie die Anweisungen und stellen Sie sicher, dass Sie alle Werkzeuge und Zubehörteile haben, um die Installation korrekt durchzuführen.

### Schritt 2

Vergewissern Sie sich vor dem Einsetzen des Adapters in den Schienenabschnitt, dass er in der Position 'OFF' steht und der 'Verriegelungshebel' in der abgebildeten Position ist.

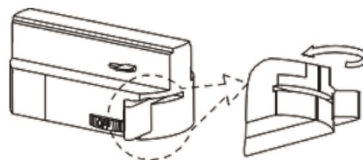

2-Drähte, 3- Drähte-Adapter

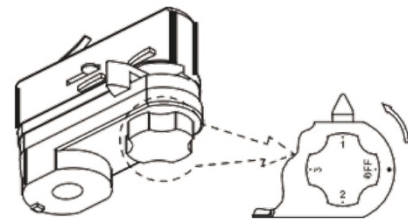

4- Drähte-Adapter

### Schritt 3

Setzen Sie den Schienenadapter in den Schienenabschnitt ein (1) & verriegeln Sie ihn durch Drehen des Verriegelungshebels um 90° (2).

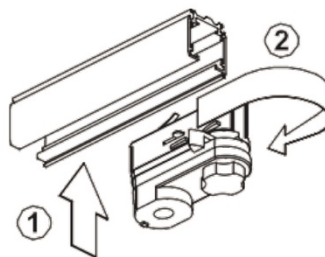
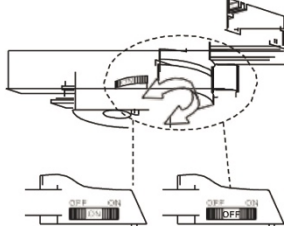

2-Drähte, 3-Drähte  
Steuerung von Leuchten  
im gleichen Stromkreis  
durch EIN/AUS-Schalter.



Streckenabschnitt

Der abgebildete  
Schienenadapter ist  
im Schienenabschnitt  
verriegelt.

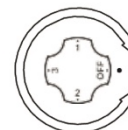

4-Drähte  
Im oder gegen  
den  
Uhrzeigersinn  
drehen.

## Schienenmontage: DECKENMONTAGE

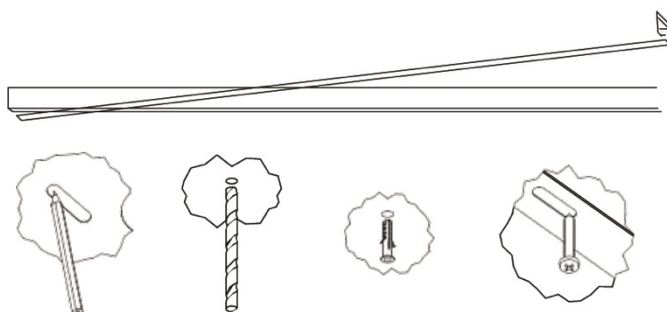

och markieren  
festigungszenetre Löcher bohren  
Dübel in das  
Loch einsetzen Fixeren in Position

Nachfolgend der Anschluss der verfügbaren  
Gleise, bitte kontaktieren Sie den Vertrieb.



Iconnector Lconnector Tconnector Xconnector



Hinweis: Nicht in der Nähe einer  
Wärmequelle oder in einer Umgebung mit  
korrosiven Gasen installieren.

## (GB) LED TRACK USER GUIDE

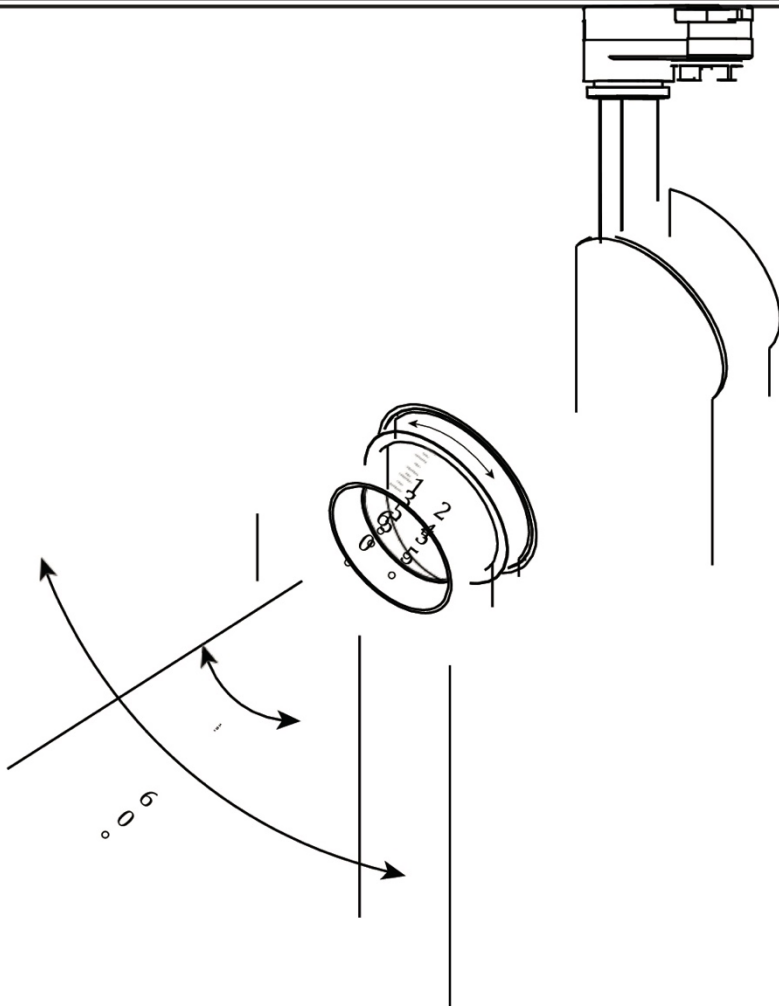

### LED TRACK LIGHT

Zoom lens adjustable manually: 15°-60°

## IMPORTANT SAFETY INSTRUCTIONS

When installing or using this track system, basic safety precautions should always be followed, including the following:

1. Read all instructions
2. Do not cut any track sections.
3. For Indoor use only. Do not install this track in damp or wet locations.
4. Do not install any part of a track system less than 5 feet above the floor.
5. Do not install any luminaire assembly closer than 6 inches from any curtain, or similar combustible material.
6. Turn off power before installation or before doing any maintenance work.
7. Do not exceed the nominal supply voltage or amperage ratings.
8. Do not attempt to energize anything other than lighting track luminaires on the track. To reduce the risk of fire and electric shock, do not attempt to connect power tools, extension cords, appliances, and the like to the track.
9. Do not connect a track to more than one branch circuit unless the track is constructed so that it can be used with more than one branch circuit. Check with a qualified electrician. Although the track lighting system may seem to operate acceptably, a dangerous overload of the neutral may occur and result in a risk of fire.
10. Wear rubber soled shoes and work on a sturdy wooded or non-conductive ladder.
11. Product must be mounted in location and at height in a manner consistent with its intended use, and in compliance with National Electrical Code and local building codes.
12. Dimmable version could be compatible with a wide range of recommended TRIAC dimmers.

## Select Adaptor Before You Buy The Track Light

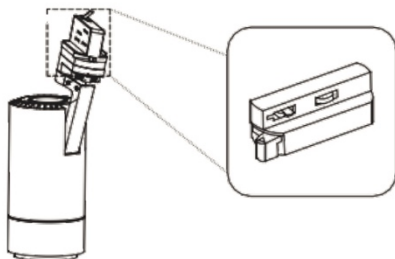

3-wires, 1-circuit

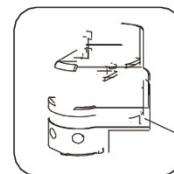

4-wires, 3-circuit

Circuit optional dial

## Wiring Diagram Of Track

### 2-wires, 1-circuit

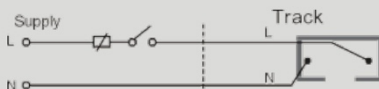

1-phase, 1-circuit, 230V AC, 16A, 3.7kVA

### 3-wires, 1-circuit

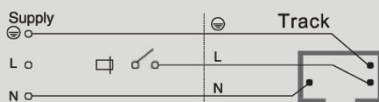

1-phase, 1-circuit, 230V AC, 16A, 3.7kVA

### 4-wires, 3-circuit

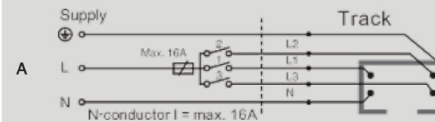

1-phase, 3-circuit,  
230V AC,  
16A, 3.7kVA

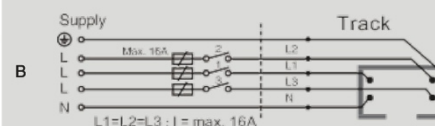

3-phase, 3-circuit,  
230/400V AC,  
16A, 3x3.7kVA

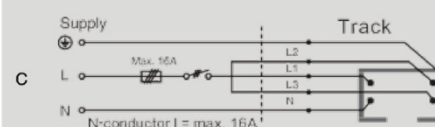

3-phase, 3-circuit,  
230/400V AC,  
16A, 11.1kVA

## Installation Procedure

### WARNING ⚡

1. Switch off before installation.
2. Switch on only after complete installation and examination of the circuit.
3. Professional electrician for installation and maintenance only.



**Turn Off  
Power Supply**

### Step 1

Turn Off power supply before starting any installation. Read instructions & check you have all the tools & accessories to complete the installation correctly.

### Step 2

Prior to locating Adaptor into Track Section make sure it is set in the 'OFF' position & 'Locking Lever' is set in the position shown.

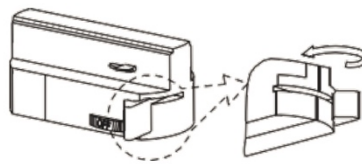

2-wires, 3-wires adaptor

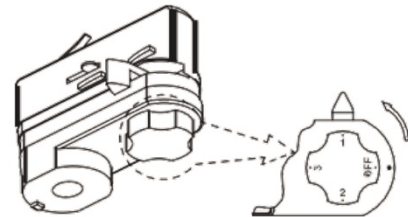

4-wires adaptor

### Step 3

Locate Track Adaptor into Track Section (1) & lock into position by turning 'Locking Lever' 90°(2)

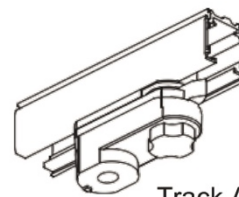
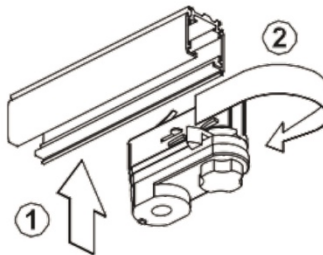

Track Section

Track Adaptor shown locked into Track Section

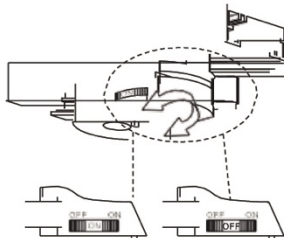

2-wires, 3-wires control luminaires in same circuit by ON/OFF switch.

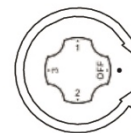

4-wires Turn clockwise or anti-clockwise.

## Track installation: CEILING MOUNTED

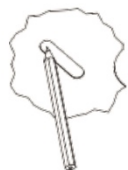

Mark hole fixing centres



Drill holes



Insert rawl plug into hole



Fix in position

Below connector of track available, please contact with sales.



I connector L connector T connector X connector



**Note: Do not install in the place near heat source, or in corrosive gas environment.**

## (FR) LED TRACK USER GUIDE

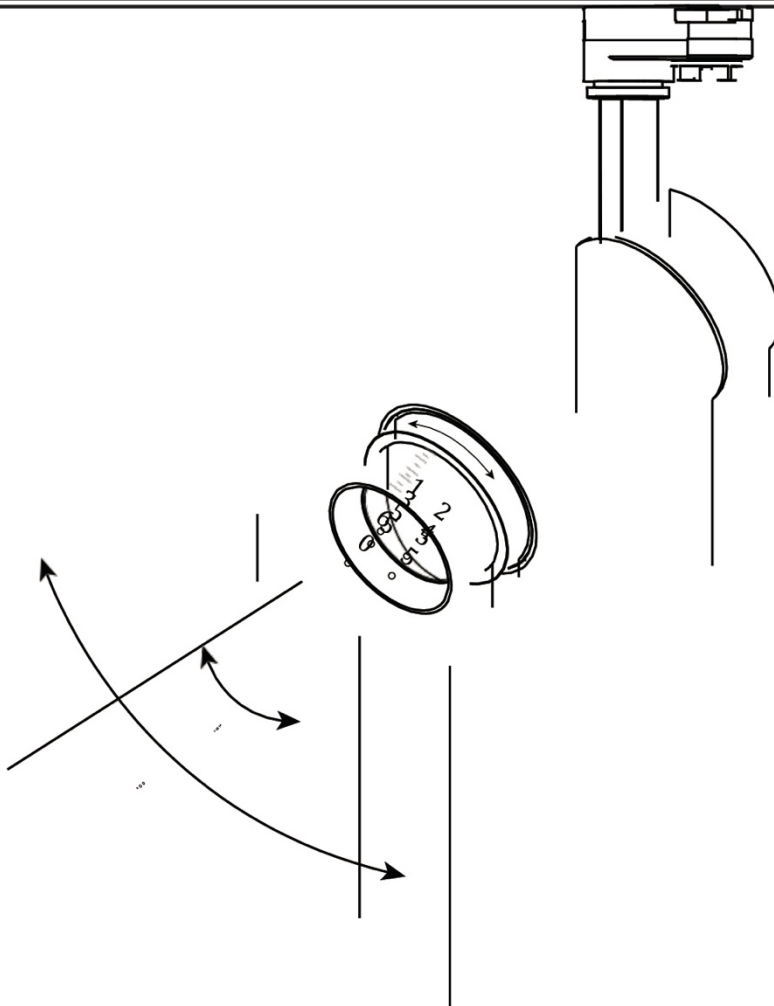

### LED TRACK LIGHT

Zoom lens adjustable manually: 15°-60°



## IMPORTANTES CONSIGNES DE SÉCURITÉ

Lors de l'installation ou de l'utilisation de ce système de chenilles, les précautions de sécurité de base doivent toujours être respectées, notamment les suivantes:

1. Lire toutes les instructions.
2. Ne coupez aucune section de rail.
3. Utilisation à l'intérieur uniquement. Ne pas installer ce rail dans des endroits humides ou mouillés.
4. N'installez aucune partie d'un système de rails à moins de 1,5 m du sol.
5. N'installez pas de luminaire à moins de 15 cm d'un rideau ou d'un matériau combustible similaire.
6. Coupez le courant avant l'installation ou avant d'effectuer tout travail d'entretien.
7. Ne dépassez pas la tension ou l'ampérage nominaux de l'alimentation.
8. N'essayez pas de mettre sous tension quoi que ce soit d'autre que les luminaires du rail d'éclairage. Pour réduire les risques d'incendie et d'électrocution, n'essayez pas de connecter des outils électriques, des rallonges, des appareils électroménagers, etc. au rail.
9. Ne connectez pas un rail à plus d'un circuit de dérivation, sauf si le rail est construit de manière à pouvoir être utilisé avec plus d'un circuit de dérivation. Vérifiez auprès d'un électricien qualifié. Bien que le système d'éclairage sur rail puisse sembler fonctionner de manière acceptable, une surcharge dangereuse du neutre peut se produire et entraîner un risque d'incendie.
10. Portez des chaussures à semelle en caoutchouc et travaillez sur une échelle solide en bois ou non conductrice.
11. Le produit doit être monté à l'endroit et à la hauteur correspondant à l'usage auquel il est destiné, et en conformité avec le Code national de l'électricité et les codes de construction locaux.
12. La version gradable peut être compatible avec une large gamme de gradateurs TRIAC recommandés.

## ■ Sélectionnez l'adaptateur avant d'acheter le lampadaire

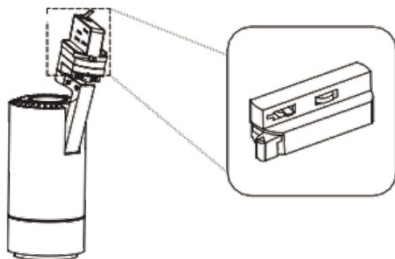

3-fils, 1-circuit

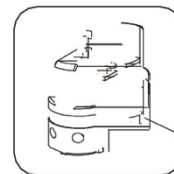

4-fils, 3-circuit

Cadran optionnel de circuit

## ■ Schéma de câblage de la voie ferrée

### 2-fils, 1-circuit

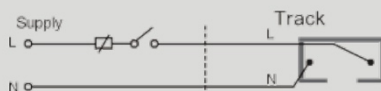

1-phase, 1-circuit, 230V AC, 16A, 3.7kVA

### 3-fils, 1-circuit

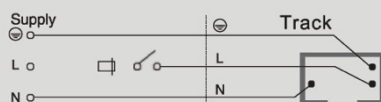

1-phase, 1-circuit, 230V AC, 16A, 3.7kVA

### 4-fils, 3-circuit

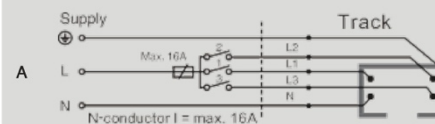

1-phase, 3-circuit,  
230V AC,  
16A, 3.7kVA

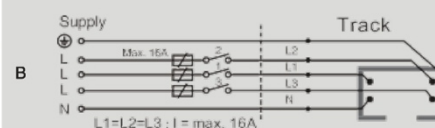

3-phase, 3-circuit,  
230/400V AC,  
16A, 3x3.7kVA

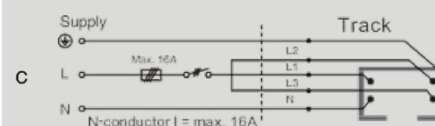

3-phase, 3-circuit,  
230/400V AC,  
16A, 11.1kVA

## Procédure d'installation

### AVERTISSEMENT

1. Mettez l'appareil hors tension avant de l'installer.
2. Ne mettez l'appareil en marche qu'après l'installation complète et l'examen du circuit.
3. Un électricien professionnel pour l'installation et l'entretien uniquement.



**Turn Off  
Power Supply**

### Étape 1

Coupez l'alimentation électrique avant de commencer toute installation. Lisez les instructions et vérifiez que vous avez tous les outils et accessoires nécessaires pour effectuer l'installation correctement.

### Étape 2

Avant de placer l'adaptateur dans la section du rail, assurez-vous qu'il est réglé sur la position "OFF" et que le levier de verrouillage est réglé sur la position indiquée.

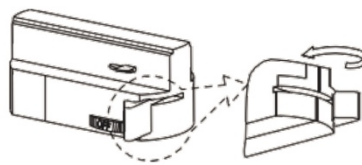

2-wires, 3-wires adaptor

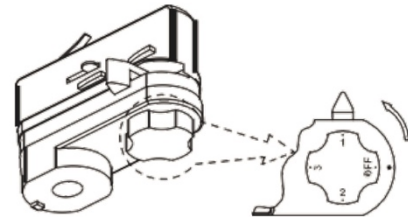

4-wires adaptor

### Étape 3

Placez l'adaptateur de rail dans la section du rail (1) & verrouillez en position en tournant le levier de verrouillage de 90° (2)

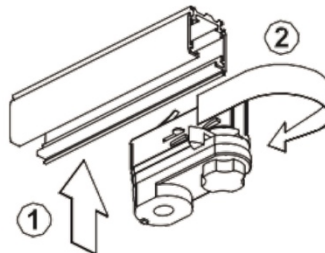

Section de la voie

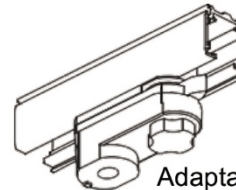

Adaptateur de rail représenté verrouillé dans la section du rail

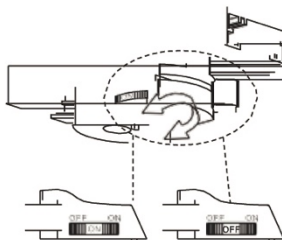

2-fils, 3-fils  
contrôler les luminaires  
d'un même circuit par un  
interrupteur ON/OFF.

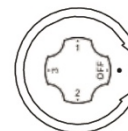

4-fils  
Tournez dans le sens  
des aiguilles d'une  
montre ou dans le  
sens inverse.

## Installation du rail : MONTAGE AU PLAFOND

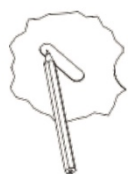

Marquer le trou  
centres de fixation



Percez des trous  
dans le trou



Insérer le  
bouchon  
dans le trou



Fixer en  
position

*Ci-dessous le connecteur de la piste disponible, s'il vous plaît*



I connector L connector T connector X connector



**Note:** Ne pas installer dans un endroit proche d'une source de chaleur, ou dans

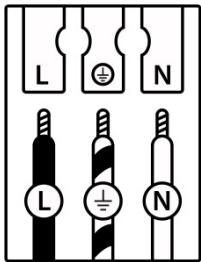

	(DE)	(GB)	(FR)	(NL)	(PL)	(NO)	(DK)
<b>L</b>	Stromführender Leiter	Live conductor	Conducteur	Spanningvoerende draad	Przewód prądowy	Strømførende leder	Strømførende leder
	Schutzleiter	Earth conductor	Conducteur de protection (terre)	Aardkabel	Przewód uziemiający	Jordledningen	Jordledningen
<b>N</b>	Neutralleiter	Neutral conductor	Conducteur neutre	Nulleider	Przewód zerowy	Nøytralleder	Neutralleider

	(SE)	(FI)	(IT)	(ES)	(CZ)	(PT)	(GR)
<b>L</b>	Strömförande ledare	Virtajohdin	Conduttore sotto tensione	Líneas conductoras de corriente	Vodič pod napětím	Condutor vivo	Ρευματοφόρος αγωγός
	Skyddsledare	Suojajohdin	Conduttore di terra	Conductor de protección	Ochranný vodič	Condutor de terra	Αγωγός γείωσης
<b>N</b>	Neutralledare	Nollajohdin	Conduttore neutro	Conductor neutro	Neutrální vodič	Condutor neutro	Ουδέτερος αγωγός

	QR	EAN
<p><b>(DE)</b> Dieses Produkt enthält eine Lichtquelle der Energieeffizienzklasse F  <b>(EN)</b> This product contains a light source of energy efficiency class F  <b>(FR)</b> Ce produit comprend une source de lumière de classe d'efficacité énergétique F  <b>(NL)</b> Dit product bevat een lichtbron van energie-efficiëntieklasse F  <b>(PL)</b> Produkt ten zawiera źródło światła o klasie efektywności energetycznej F  <b>(NO)</b> Dette produktet inneholder en lyskilde i energieeffektivitetsklasse F  <b>(DK)</b> Dette produkt indeholder en lyskilde af energieeffektklasse F  <b>(SE)</b> Denna produkt innehåller en ljuskälla i energieffektivitetsklass F  <b>(FI)</b> Tämä tuote sisältää energiatehokkuusluokan F valonlähteen  <b>(IT)</b> Questo prodotto contiene una sorgente luminosa della classe di efficienza energetica F  <b>(ES)</b> Este producto contiene una fuente de luz de la clase de eficiencia energética F  <b>(CZ)</b> Tento výrobek obsahuje světelný zdroj třídy energetické účinnosti F  <b>(PT)</b> Este produto contém uma fonte de luz da classe de eficiência energética F  <b>(GR)</b> Αυτό το προϊόν περιέχει μια φωτεινή πηγή ενεργειακής απόδοσης κλάσης F  <b>(SK)</b> Tento výrobok obsahuje zdroj svetla triedy energetickej efektivity F</p>		4251911753738

	<p><b>(DE)</b> Durch einen Fachmann austauschbare Lichtquelle (nur LED).  <b>(EN)</b> Replaceable (LED only) light source by a professional.  <b>(FR)</b> Source de lumière remplaçable (LED uniquement) par un professionnel.  <b>(NL)</b> Lichtbron (alleen led) te vervangen door een professional.  <b>(PL)</b> Wymienne (tylko LED) źródło światła wykonane przez profesjonalistę.  <b>(NO)</b> Utskiftbar (kun LED) lyskilde av en profesjonell.  <b>(DK)</b> Udskiftelig lyskilde (kun LED), udskiftes af en elektriker.  <b>(SE)</b> Ljuskälla (endast LED) utbyttbar genom fackman.  <b>(FI)</b> Ammattilainen voi vaihtaa vaihdettavan (vain LED) valonlähteen.  <b>(IT)</b> Sorgente luminosa (solo LED) sostituibile da un professionista.  <b>(ES)</b> Fuente de luz (solo LED) sustituible por un profesional.  <b>(CZ)</b> Vyměnitelný (pouze LED) světelný zdroj odborníkem.  <b>(PT)</b> Luz LED (apenas LED) substituível por um profissional.  <b>(GR)</b> Η πηγή φωτός (μόνο LED) να αντικαθίσταται από επαγγελματία.  <b>(SK)</b> Zdroj svetla (iba LED) vymeniteľný prostredníctvom odborníka.</p>
--	--

	<p><b>(DE)</b> Durch einen Fachmann austauschbares Betriebsgerät.  <b>(EN)</b> Replaceable control gear by a professional.  <b>(FR)</b> Contrôleur remplaçable par un professionnel.  <b>(NL)</b> Voorschakelapparatuur te vervangen door een professional.  <b>(PL)</b> Wymienny układ sterujący przez profesjonalistę.  <b>(NO)</b> Utskiftbar kontrollutstyr av en profesjonell.  <b>(DK)</b> Udskiftelig igangsætter, udskiftes af en elektriker.  <b>(SE)</b> Styrdon utbyttbart genom fackman.  <b>(FI)</b> Ammattilainen voi vaihtaa vaihdettavat ohjauslaitteet.  <b>(IT)</b> Dispositivo di controllo sostituibile da un professionista.  <b>(ES)</b> Dispositivo de control sustituible por un profesional.  <b>(CZ)</b> Vyměnitelný předřadník odborníkem.  <b>(PT)</b> Dispositivo de controlo substituível por um profissional.  <b>(GR)</b> Ο εξοπλισμός ελέγχου να αντικαθίσταται από επαγγελματία.  <b>(SK)</b> Predradník vymeniteľný prostredníctvom odborníka.</p>
--	---