

# Installation / Montageanweisungen

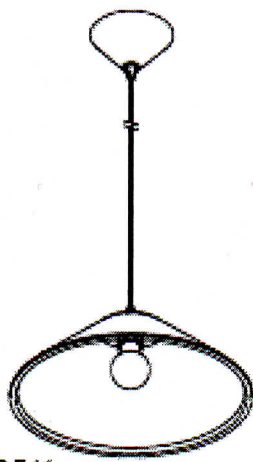

HL 6-1525/1

H=130

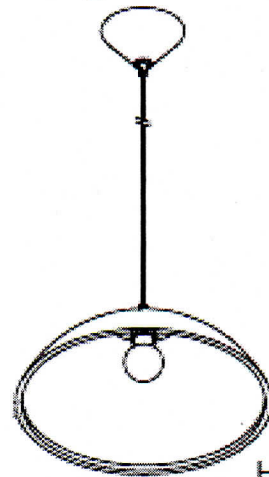

HL 6-1524/1

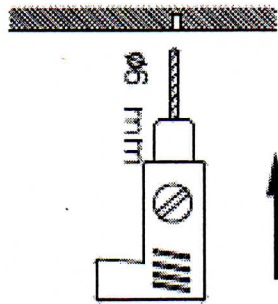

①

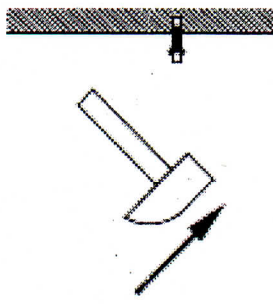

②



③

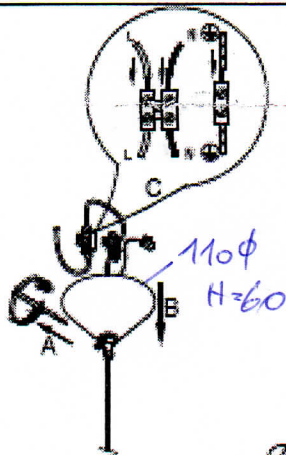

④

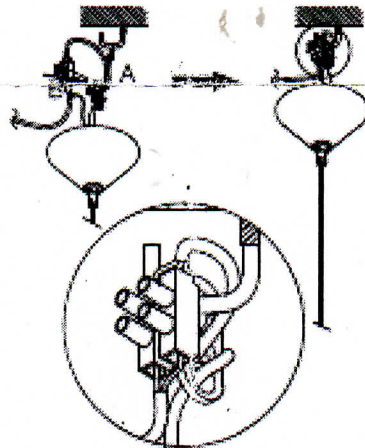

⑤

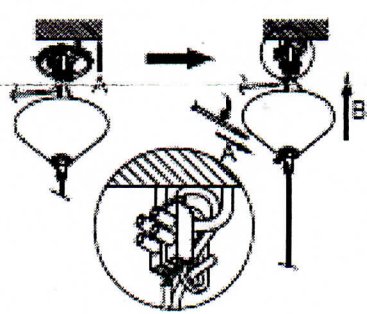

⑥

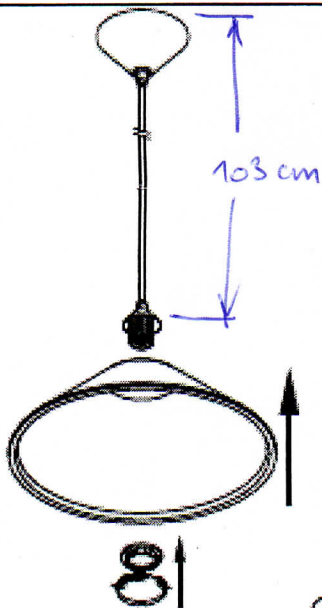

⑦

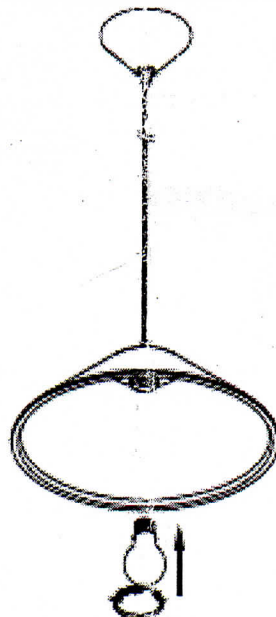

⑧

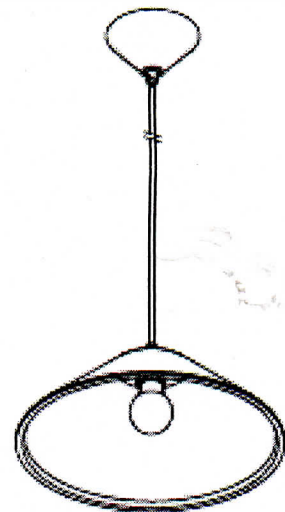

⑨