

## 10020191

4,2W LED / 5W Total  
incl. 3x LED Board: L9002814  
220-240V ~ 50Hz

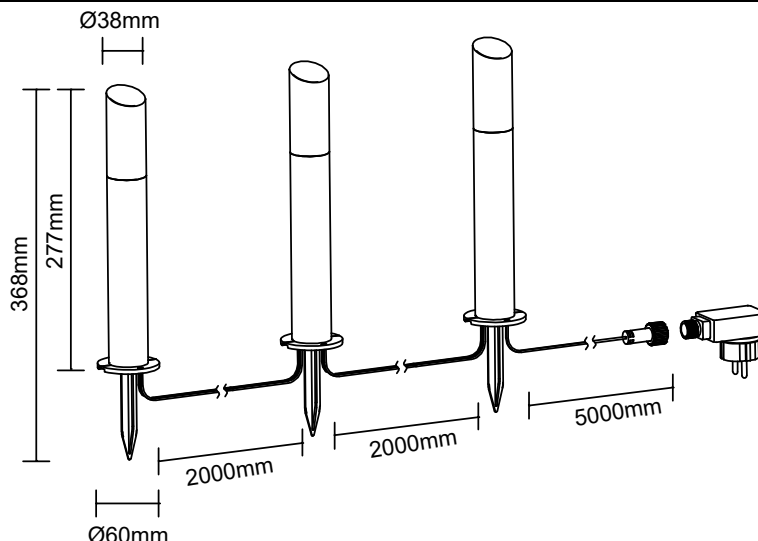

### (DE) Bestimmungsgemäße Verwendung

(GB) Intended use / (FR) Utilisation conforme / (NL) Beoogd gebruik / (PL) Stosowanie zgodnie z przeznaczeniem / (NO) Riktig bruk / (DK) Korrekt brug / (SE) Avsedd användning / (FI) Määräystenmukainen käyttö

(IT) Impiego appropriato / (ES) Uso prescrito / (CZ) Použití v souladu s určením / (PT) Utilização correta / (GR) Ενδεδειγμένη χρήση

(DE)	Ortsveränderliche Verwendung an Wegen/in Beeten im Außenbereich	(GB)	Portable light for use outdoors on paths or in flowerbeds
(FR)	Pose amovible le long des allées/des parterres de plantes, à l'extérieur	(NL)	Verplaatsbaar en te gebruiken langs paden en bloembedden buitenshuis
(PL)	Do montażu przenośnego na zewnątrz przy drogach/grządkach	(NO)	Transportabel bruk på veier og i bedd utendørs
(DK)	Transportabel brug på veje og i bed udendørs	(SE)	Bärbar användning vid stigar/rabatter utomhus
(FI)	Paikasta riippumaton käyttö ulkotilojen kulkureiteillä/kukkapenkeissä	(IT)	Impiego mobile su sentieri/aiuole in ambienti esterni
(ES)	Empleo ambulante en caminos / jardineras en el exterior	(CZ)	Mobilní použití u cestiček / v záhonech v exteriéru
(PT)	Aplicação móvel para caminhos/ canteiros em exteriores	(GR)	Κινητή χρήση σε διαδρόμους/παρτέρια σε εξωτερικό χώρο

### (DE) Verwendete Symbole

(GB) Safety Precautions / (FR) Symboles utilisés / (NL) Gebruikte symbolen / (PL) Stosowane symbole / (NO) Brukte symboler / (DK) Brugte symboler / (SE) Använda symboler / (FI) Käytetyt symbolit / (IT) Simboli usati / (ES) Símbolos empleados / (CZ) Použité symboly / (PT) Símbolos utilizados / (GR) Χρησιμοποιούμενα σύμβολα











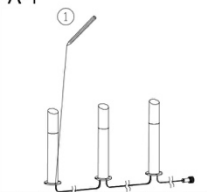
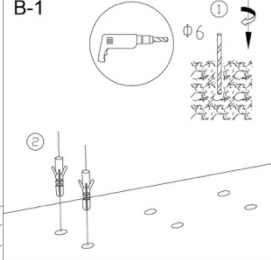
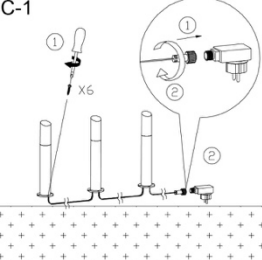
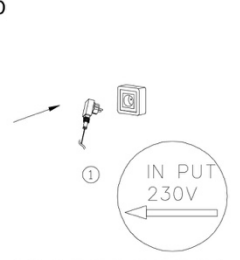

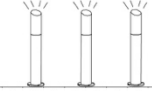
IP 44

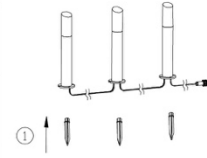
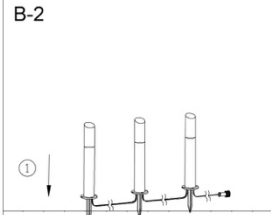
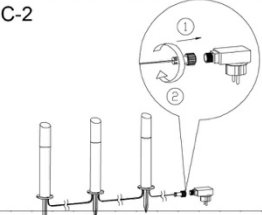

### (DE) Lieferumfang

(GB) Package contents / (FR) Contenu de la livraison / (NL) Bij de levering inbegrepen / (PL) Zakres dostawy / (NO) Levering / (DK) Leveringsomfang / (SE) Leveransomfattning / (FI) Toimitussisältö / (IT) Fornitura / (ES) Volumen de suministro / (CZ) Rozsah dodávky / (PT) Material fornecido / (GR) Παραδοτέος εξοπλισμός

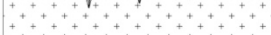
(DE)	1 Spießleuchte Montagematerial Montageanleitung	(GB)	1 Spike spot Installation hardware Mounting instructions	(FR)	1 Lampe à piquer en terre Matériel de montage Instructions de montage
(NL)	1 Prikspot Monteringsmateriale Montagehandleiding	(PL)	1 Lampa z grotem ziemnym Elementy montażowe Instrukcja montażu	(NO)	1 Lampe med spyd Monteringsmateriale Brukerveiledning
(DK)	1 Lampe med spyd Monteringsmateriale Brugervejledning	(SE)	1 Markspett Monteringsmaterial Monteringsanvisning	(FI)	1 Maapiikki Asennus materiaali Asennusohjeet
(IT)	1 Picchetto Materiale di montaggio Istruzioni di montaggio	(ES)	1 Estaca Material de montaje Instrucciones de montaje	(CZ)	1 Zapichovací svítilno Materiál pro montáž Návod k montáži
(PT)	1 Luminária tipo espeto Material de montagem Instruções de montagem	(GR)	1 Ράβδος γείωσης Υλικό συναρμολόγησης Οδηγίες συναρμολόγησης		

10020191 Parts Supplied		A-1	B-1	C-1	D
	X1				
	X1	A-2	B-2	C-2	
	X3				
	X6				
	X6				

<p><b>(DE)</b> Dieses Produkt enthält eine Lichtquelle der Energieeffizienzklasse F  <b>(EN)</b> This product contains a light source of energy efficiency class F  <b>(FR)</b> Ce produit comprend une source de lumière de classe d'efficacité énergétique F  <b>(NL)</b> Dit product bevat een lichtbron van energie-efficiëntieklasse F  <b>(PL)</b> Produkt ten zawiera źródło światła o klasie efektywności energetycznej F  <b>(NO)</b> Dette produktet inneholder en lyskilde i energieeffektivitetsklasse F  <b>(DK)</b> Dette produkt indeholder en lyskilde af energieeffektklasse F  <b>(SE)</b> Denna produkt innehåller en ljuskälla i energieeffektivitetsklass F  <b>(FI)</b> Tämä tuote sisältää energiatehokkuusluokan F valonlähteen  <b>(IT)</b> Questo prodotto contiene una sorgente luminosa della classe di efficienza energetica F  <b>(ES)</b> Este producto contiene una fuente de luz de la clase de eficiencia energética F  <b>(CZ)</b> Tento výrobek obsahuje světelný zdroj třídy energetické účinnosti F  <b>(PT)</b> Este produto contém uma fonte de luz da classe de eficiência energética F  <b>(GR)</b> Αυτό το προϊόν περιέχει μια φωτεινή πηγή ενεργειακής απόδοσης κλάσης F  <b>(SK)</b> Tento výrobok obsahuje zdroj svetla triedy energetickej efektivity F</p>	<p><b>QR</b></p> 	<p><b>EAN</b></p> <p>4251911780956</p>
--	---	--

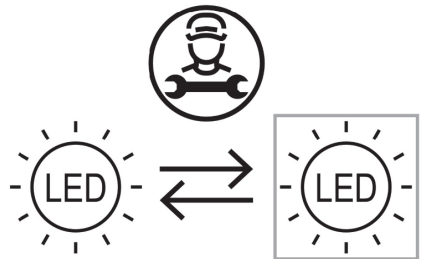
	<p><b>(DE)</b> Durch einen Fachmann austauschbare Lichtquelle (nur LED).  <b>(EN)</b> Replaceable (LED only) light source by a professional.  <b>(FR)</b> Source de lumière remplaçable (LED uniquement) par un professionnel.  <b>(NL)</b> Lichtbron (alleen led) te vervangen door een professional.  <b>(PL)</b> Wymienne (tylko LED) źródło światła wykonane przez profesjonalistę.  <b>(NO)</b> Utskiftbar (kun LED) lyskilde av en profesjonell.  <b>(DK)</b> Udskiftelig lyskilde (kun LED), udskiftes af en elektriker.  <b>(SE)</b> Ljuskälla (endast LED) utbytbar genom fackman.  <b>(FI)</b> Ammattilainen voi vaihtaa vaihdettavan (vain LED) valonlähteen.  <b>(IT)</b> Sorgente luminosa (solo LED) sostituibile da un professionista.  <b>(ES)</b> Fuente de luz (solo LED) sustituible por un profesional.  <b>(CZ)</b> Vyměnitelný (pouze LED) světelný zdroj odborníkem.  <b>(PT)</b> Luz LED (apenas LED) substituível por um profissional.  <b>(GR)</b> Η πηγή φωτός (μόνο LED) να αντικαθίσταται από επαγγελματία.  <b>(SK)</b> Zdroj svetla (iba LED) vymeniteľný prostredníctvom odborníka.</p>
---	---

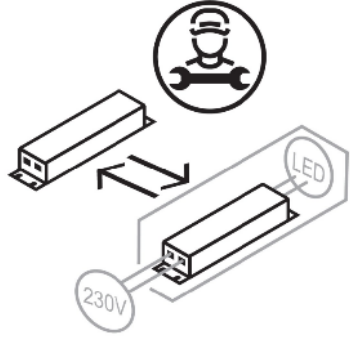
	<p><b>(DE)</b> Durch einen Fachmann austauschbares Betriebsgerät.  <b>(EN)</b> Replaceable control gear by a professional.  <b>(FR)</b> Contrôle remplaçable par un professionnel.  <b>(NL)</b> Voorschakelapparatuur te vervangen door een professional.  <b>(PL)</b> Wymienny układ sterujący przez profesjonalistę.  <b>(NO)</b> Utskiftbar kontrollutstyr av en profesjonell.  <b>(DK)</b> Udskiftelig igangsætter, udskiftes af en elektriker.  <b>(SE)</b> Styrdon utbytbar genom fackman.  <b>(FI)</b> Ammattilainen voi vaihtaa vaihdettavat ohjauslaitteet.  <b>(IT)</b> Dispositivo di controllo sostituibile da un professionista.  <b>(ES)</b> Dispositivo de control sustituible por un profesional.  <b>(CZ)</b> Vyměnitelný předřadník odborníkem.  <b>(PT)</b> Dispositivo de controlo substituível por um profissional.  <b>(GR)</b> Ο εξοπλισμός ελέγχου να αντικαθίσταται από επαγγελματία.  <b>(SK)</b> Predradník vymeniteľný prostredníctvom odborníka.</p>
---	---