

Chip Ovale/Tondo

Importante, Important, Wichtig, Importante, Pomembno, Upozornenie, Σημαντικό, Важно, هام

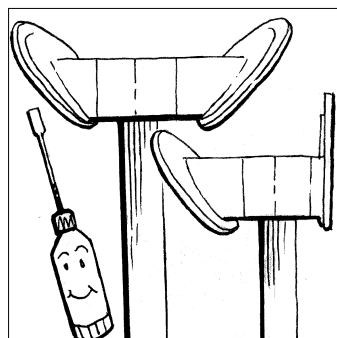

Installazione dell'apparecchio, How to install the luminaire, Installation de l'appareil, Installation der leuchte, Instalación del aparato, Instalação do aparelho, Kako Montirati svetilko, Inštalácia svetidla, ΕΓΚΑΤΑΣΤΑΣΗ ΤΗΣ ΣΥΣΚΕΥΗΣ, Установка (прибора) светильника, تركيب الجهاز

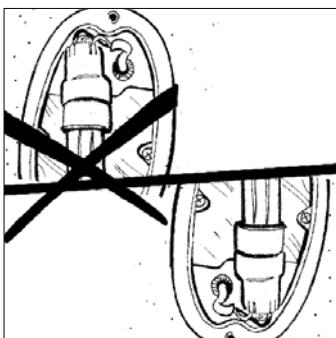
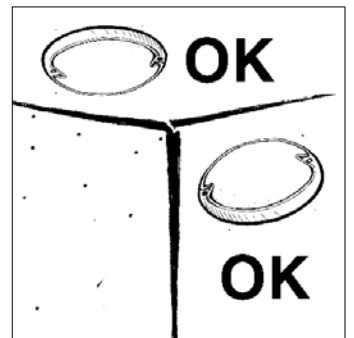
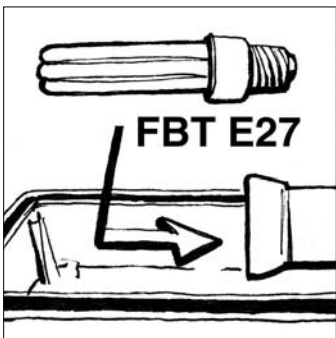
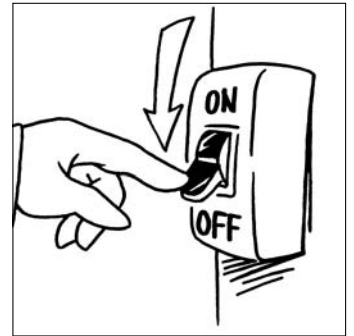
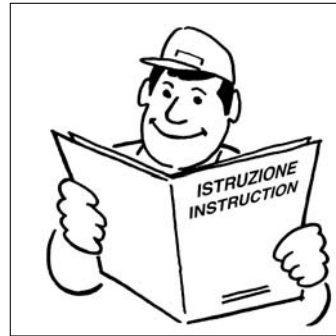
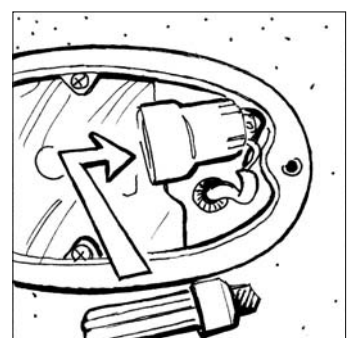
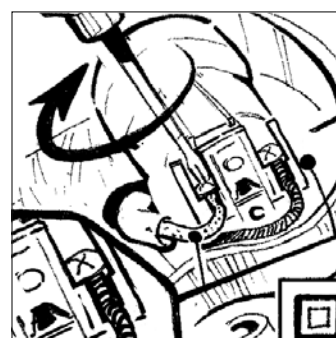
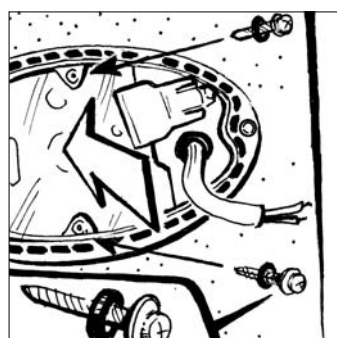
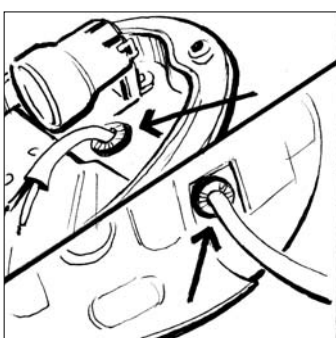
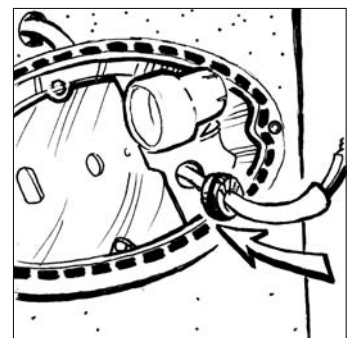
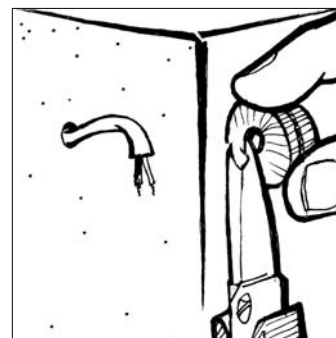
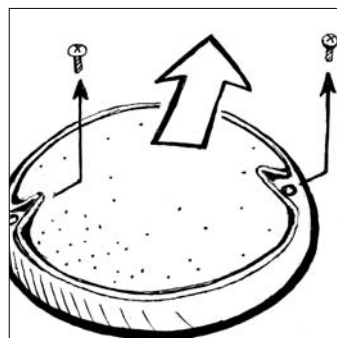
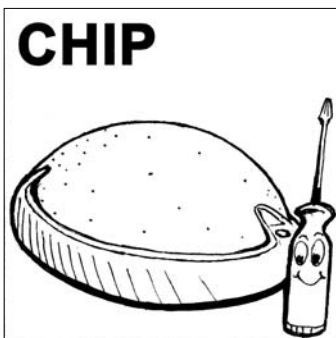

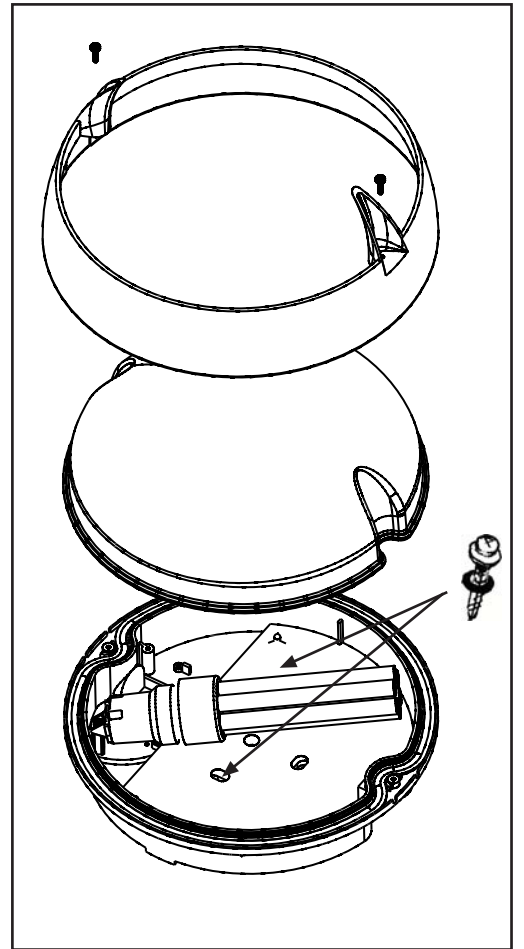
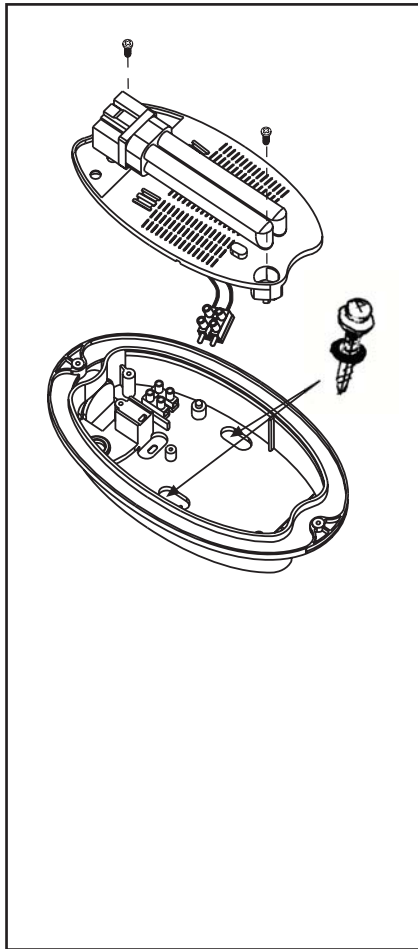
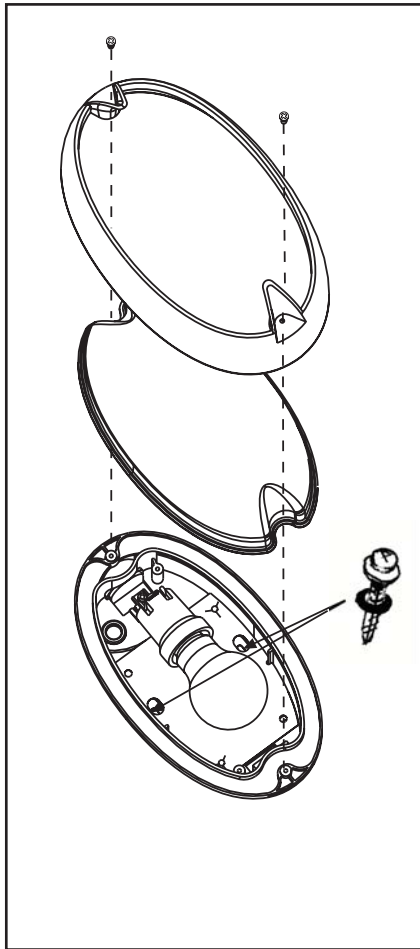
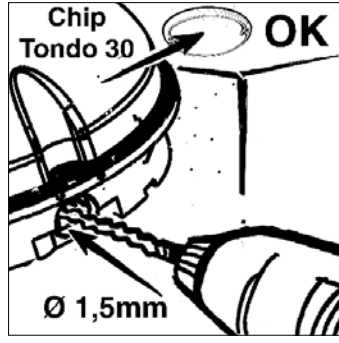
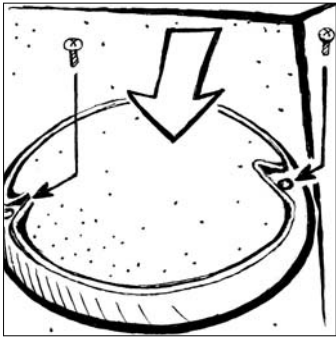

Modifiche o manomissioni del prodotto senza l'autorizzazione del costruttore, comportano il decadimento della garanzia e della responsabilità della PERFORMANCE IN LIGHTING S.p.A.

Any misuse or any modification of the product not expressly authorised by the manufacturer is hazardous and makes the warranty nil and void.

La modification ou la falsification des produits sans l'autorisation du fabricant entraine la déclinacion de la garantie et de la responsabilité de PERFORMANCE IN LIGHTING S.p.A.

Bei Veränderungen am Produkt ohne ausdrückliche Autorisierung des Herstellers oder nicht bestimmungsgemäßem Gebrauch erlöschen die Garantie und die Verantwortlichkeit der PERFORMANCE IN LIGHTING S.p.A.

Modificaciones o menoscabos del producto sin la autorización del fabricante comportan el decaimiento de la garantía y de la responsabilidad de PERFORMANCE IN LIGHTING S.p.A.

Modificações ou alterações do produto sem autorização do fabricante comporta a perda da garantia e da responsabilidade de PERFORMANCE IN LIGHTING S.p.A.

Kakršnokoli spreminjanje izdelka in poseganje v izdelek brez predhodne odobritve proizvajalca (PERFORMANCE IN LIGHTING S.p.A.) čje prepovedano in nevarno. V tem primeru izdelek izgubi pravico do uveljavljanja garancije.

Autorizovaný výrobca PERFORMANCE IN LIGHTING S.p.A. sa nezaručuje za vlastnosti stanovené technickými normami a nie je zodpovedný za následky a škody na tovare, spôsobené nesprávnou inštaláciou alebo nesprávnym spôsobom použitia.

Αν γίνονται τροποποιήσεις ή παραποίηση του προϊόντος χωρίς την έγκριση του κατασκευαστή, παύει να ισχύει η εγγύηση και δεν δύναται να ζητηθούν ευθύνες από την PERFORMANCE IN LIGHTING S.p.A.

Подделка или изменение продукции без согласия производителя отменяют гарантию и ответственность PERFORMANCE IN LIGHTING S.p.A.

يؤدي تعديل المنتج والعبث به دون الحصول على تصريح من
الصانع، إلى انتهاء مفعول شهادة الضمان ومسئولية شركة
PERFORMANCE IN LIGHTING S.p.A.

Vietata la riproduzione, anche parziale, senza l'autorizzazione scritta di PERFORMANCE IN LIGHTING S.p.A. Colognola ai Colli (Verona).

Notice: any reproduction of the contents of this sheet without prior written consent of PERFORMANCE IN LIGHTING S.p.A. is prohibited.

La reproduction, même partielle des appareils, est interdite sans l'autorisation écrite de PERFORMANCE IN LIGHTING S.p.A. Colognola ai Colli (Verona).

Jegliche Vervielfältigung, auch auszugsweise, ist ohne vorherige schriftliche Genehmigung durch die PERFORMANCE IN LIGHTING S.p.A. Colognola ai Colli (Verona), untersagt.

Prohibida la reproducción aunque parcial sin la autorización escrita por parte de PERFORMANCE IN LIGHTING S.p.A.

Proibida a reprodução, também parcial, sem a autorização escrita de PERFORMANCE IN LIGHTING S.p.A.

Prepovedano je kopiranje in uporaba vsebine dokumenta brez predhodne pisne odobritve PERFORMANCE IN LIGHTING S.p.A.

Akékoľvek kopírovanie a reprodukcia obsahu je zakázaná a je výhradne dovolená iba s písomným súhlasom výrobcu, ktorým je PERFORMANCE IN LIGHTING S.p.A.

Απαγορεύεται η αναπαραγωγή, έστω και τμηματικά, χωρίς την γραπτή έγκριση από την PERFORMANCE IN LIGHTING S.p.A.
- Χολογνόλα αιΧολλι (ηερονα).

Примечание: даже частичная перепечатка содержания этой инструкции без согласия PERFORMANCE IN LIGHTING S.p.A. запрещена.

ممنوع إعادة الإنتاج حتى ولو بشكل جزئي، دون الحصول على
تصريح مكتوب من شركة
PERFORMANCE IN LIGHTING S.p.A.
في بلدة Colognola ai Colli (Verona).

PERFORMANCE IN LIGHTING S.p.A.

Viale del Lavoro 9/11 - 37030 Colognola ai Colli (VR) - Italia - Tel. +39.045.61.59.211 - Fax +39.045.61.59.292 - www.performanceinlighting.com