

1

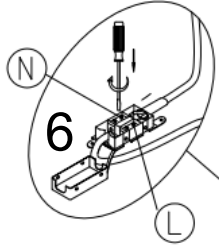

6

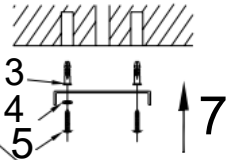

8

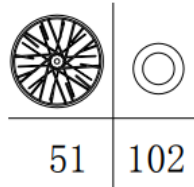

51

102

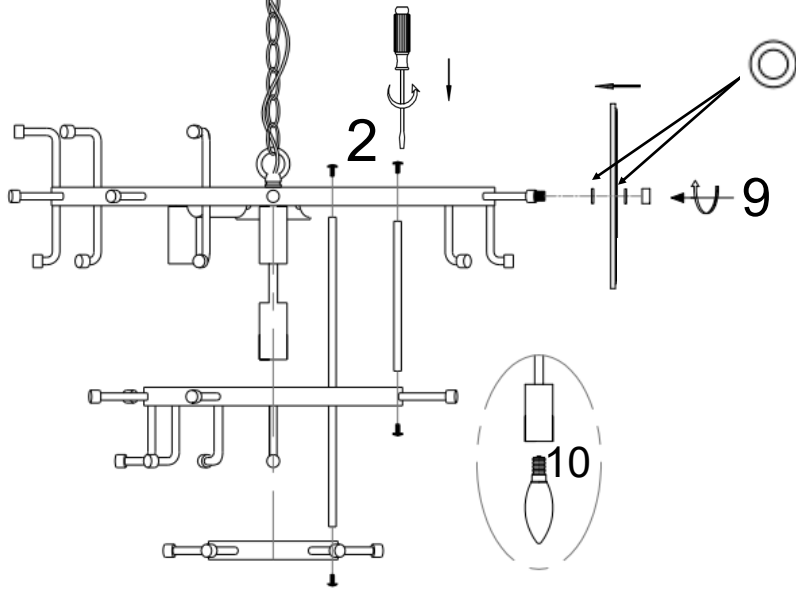

2

9

10

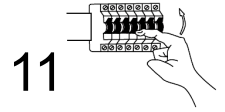

11

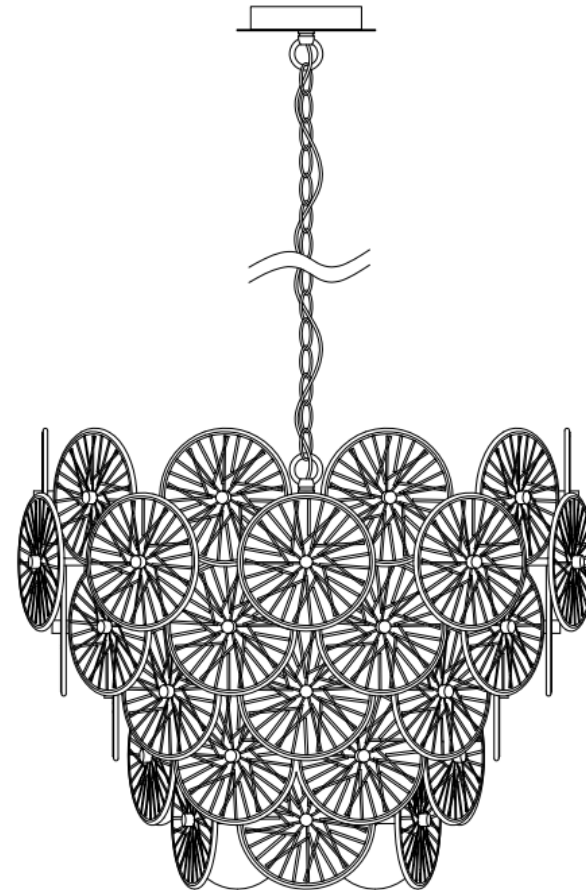

APPROVED  
12/4/2023  
ISSUE 1  
Q.C

**MAINS SUPPLY**

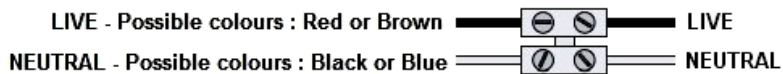

**LIGHT FITTING**

